

# RONIN



WELCOME TO  
THE #UNSCRIPTED LIFE!

OWNERS MANUAL

TVS  
**RONIN**



ALWAYS USE TVS-M GENUINE PARTS



CONTACT(S) FOR SUPPORT	1
FOREWORD	5
SAFETY INFORMATION	6
NOTICE	7
RUNNING-IN INFORMATION	8
ANTI-LOCK BRAKING SYSTEM	9
SAFE RIDING TIPS	14
KNOW YOUR TVS RONIN	18
RIDING YOUR TVS RONIN	76
MAINTENANCE	82
WARRANTY AND SERVICES	107
EXPRESS SERVICE	113
EXPERT ON WHEELS	114
PICKUP AND DROP	115
TECHNICAL SPECIFICATIONS	116
GENERAL INFORMATION	122



**Incase you need any clarification please contact**

**TVS Motor Company Authorised Main Dealer / Authorised Dealer**

**Or**

**TVS Motor Company's Area Offices (flip over for addresses)**

**Or**

**Toll Free Number : 1800-258-7111**

**Email : [customercare@tvsmotor.com](mailto:customercare@tvsmotor.com)**

**Disclaimer :** TVS Motor Company or any of its officials / Authorized Main dealer / Authorized Dealer do not ask customers for bank / card / wallet details / authentication. In case you face any such claim, please report to the relevant local authorities immediately.

## CONTACT AT OUR AREA OFFICES

### TAMILNADU-1, 3 & 4

#### 1. TVS Motor Company Limited

V Floor, Gee Gee Universal,  
No. 2, MC Nichols Road,  
Chetpet, Chennai - 600 031.  
Phone : 044-28361651/28361654  
Email : AO.Chennai@tvsmotor.com  
AO.Madurai@tvsmotor.com

### TAMILNADU-2

#### 2. TVS Motor Company Limited

No. 10, 2nd floor,  
Shree Shanmugapriya Towers,  
Kannuswamy Street,  
Behind Hotel Annapoorna,  
R S Puram, Coimbatore - 641 002.  
Phone : 0422-4350060/2541035  
Email : AO.Coimbatore@tvsmotor.com

### KERALA

#### 3. TVS Motor Company Limited

Ambady Towers, Second Floor,  
Door No. 27/631, A6,  
Edappally-Pookkattupady Road,  
Edappally PO., Cochin - 682 024.  
Phone : 0484-2544578/2556938  
Email : AO.Cochin@tvsmotor.com

### KARNATAKA-1, 2 & GOA

#### 4. TVS Motor Company Limited

No. 600, Anand Surya, 2nd Floor,  
15th Cross, 6th Phase, JP Nagar,  
Opp. BMTC Bus Stop,  
Bangalore - 560 078.  
Phone : 080-26653433  
Email : AO.Bangalore@tvsmotor.com  
AO.Hubli@tvsmotor.com

### ANDHRAPRADESH -1 & 2

#### 5. TVS Motor Company Limited

Rukamani Towers, First Floor,  
No. 3-11-30, Plot No. 11,  
Paigha Colony, Behind Anand Theater,  
Secunderabad - 500 003.  
Phone : 040-27840590/27844419  
Email : AO.Hyderabad@tvsmotor.com  
AO.Vijayawada@tvsmotor.com

### MAHARASHTRA-1 & 2

#### 6. TVS Motor Company Limited

No. 401, 4th Floor, The Chambers,  
Plot No. 4/12/3, Near Ganapati Chowk,  
Viman Nagar, Pune - 411 014.  
Phone : 020-26632111/26632110  
Email : Service.pune@tvsmotor.com

### MAHARASHTRA-3 & CHATTISGARH

#### 7. TVS Motor Company Limited

No. 502B, 6th Floor, B Wing,  
Shriram Shyam Towers,  
Near LIC Square, Sardar,  
Nagpur - 440 001.  
Phone : 0712-2569932  
Email : Service.Nagpur@tvsmotor.com  
AO.Raipur@tvsmotor.com

### GUJARATH

#### 8. TVS Motor Company Limited

109, Ayna Complex,  
Opp. Suvarna Villa Bungalows,  
100 ft Thaltej Hebbatpur Road,  
Off : S.G. Highway, Thaltej,  
Ahmedabad - 380 054.  
Phone : 079-65443748  
Email : AO.Ahmedabad@tvsmotor.com

## MADHYA PRADESH-1 & 2

### 9. TVS Motor Company Limited

No. 211-212, 2nd Floor,  
Chinar Incube Business Centre,  
Chinar Fortune City,  
Near Brindhavan Dhaba,  
Hosangabad Road,  
Bhopal - 462 026.  
Phone : 0755-2499406/2499306  
Email : AO.Bhopal@tvs motor.com  
AO.Indore@tvs motor.com

## RAJASTHAN-1 & 2

### 10. TVS Motor Company Limited

Plot No. 17-18,  
2nd Floor of National Motors Building,  
Jhotwara Industrial Area,  
Jaipur - 302 012.  
Phone : 0141-5150901/5150902  
Email : AO.Jaipur@tvs motor.com  
AO.Udaipur@tvs motor.com

## DELHI & HARYANA

### 11. TVS Motor Company Limited

D-3 & D-4, 2nd Floor,  
Sector - 10, Noida,  
Uttar Pradesh - 201 301.  
Phone : 011-29834640/29834773  
Email : AO.Delhi@tvs motor.com  
AO.Haryana@tvs motor.com

## PUNJAB & CHANDIGARH

### 12. TVS Motor Company Limited

4th Floor, Royal Business Park,  
Chandigarh Ambala Highway,  
Zirkapur - 140 603.  
Phone : 01762-464777/465777  
Email : AO.Chandigarh@tvs motor.com

## UTTAR PRADESH WEST

### 13. TVS Motor Company Limited

D-3 & D-4, 2nd Floor,  
Sector - 10, Noida,  
Uttar Pradesh - 201 301.  
Phone : 011-29834640/29834773  
Email : AO.Upw@tvs motor.com

## UTTAR PRADESH CENTRAL & EAST

### 14. TVS Motor Company Limited

1st Floor, Cyber Tower, TC-34/V-2,  
Vibhuti Khand, Gomti Nagar,  
Lucknow - 226 010.  
Phone : 0522-4918300/4918301  
Email : AO.Upe@tvs motor.com  
AO.Upc@tvs motor.com

## WEST BENGAL

### 15. TVS Motor Company Limited

Ground Floor & First Floor,  
133 A. S. P. Mukherjee Road,  
Opp. Tollygunge Police Station,  
Kolkatta - 700 026.  
Phone : 033-24617096/24617092  
Email : AO.Kolkatta@tvs motor.com

## BIHAR

### 16. TVS Motor Company Limited

N-Plaza, Jamal Road,  
P.S. Kotwali,  
Patna - 800 001.  
Phone : 0612-2200068/2200069  
Email : AO.BNJ@tvs motor.com

## ORISSA & JHARKHAND

### 17. TVS Motor Company Limited

No. 303, 3rd Floor,  
Creative Plaza, Rasulgarh,  
Bhubaneswar - 751 010.  
Phone : 0674-2580019  
Email : AO.Bhubaneswar@tvs motor.com

## NORTH EAST STATES

### 18. TVS Motor Company Limited

147, Udayan, Ganesh Guri,  
Opp. Punjab National Bank,  
R G B. Road, Guwahati - 781 005.  
Phone : 0361-2202030/2202031  
Email : AO.Guwahati@tvs motor.com

**Welcome to your new story! A story in which you will use your new TVS RONIN to explore the many facets of life.**

**Whether it's a daily ride, a weekend getaway, or a long and exciting tour, your TVS RONIN is built to take you, wherever your heart pleases.**

---

With its 225cc Oil Cooled engine, 19.9Nm of torque and 20.4 PS of power, it's the only bike that clubs the best of power and manoeuvrability. Its front Upside Down Suspension (USD) makes it very stable, while the rear mono-shock suspension always keeps you comfortable. Your bike also comes with Rain & Urban ABS modes, so you can ride with confidence in any weather. Make sure to visit our website and experience the virtual configurator which lets you add a whole range of accessories. Plus, you can now download the TVS SmartXonnect App (only in the TVS Ronin TD variant) and pair it with your bike to unlock all its smart features.

This instruction manual will help you learn all about your new bike and how to make the most of its state-of-the-tech features. Also, be sure to get your bike serviced **ONLY** at authorised TVS service centres. It's the only way to ensure smooth operation and a long life for your new bike.

We at TVS want you to always be safe while riding, so please make sure you wear a helmet every time you ride out. And we've got you covered there too! From stylish riding helmets to an extensive range of TVS RONIN merchandise and accessories, everything you would ever need for your bike is available on our website - <http://tvs-motor.com/tvs-ronin>



Operating this vehicle safely is an important responsibility of the rider. To help you make decisions on safety, we have provided necessary operating procedure and other information in the owner's manual. This information alerts you on potential hazards that could hurt you or others. Since it is not possible to warn you about all the hazards associated with operating or maintaining the vehicle, you must use your own judgement.

You will find important safety information in following form in this manual. These words carry the following connotations:

 **Warning**

*Disregarding this message might result in **injury to the rider or deadly accidents.***

 **Caution**

*This message indicates special procedures or precautions to be followed to **avoid damage to the vehicle.***

 **Note**

*This message provides further clarification for **clear understanding of any particular information.***

Take time to familiarize yourself with your TVS RONIN and its performance characteristics.

This Owner's Manual contains a host of useful information. Please take the time to read this manual before you ride your new TVS RONIN. Get familiarised with the operation of your motorcycle for maximum safety and pleasure. The better you know your vehicle, the more pleasure you will experience riding your new vehicle. Ensure that anyone else riding your TVS RONIN does the same.

All information, illustrations, photographs and specifications contained in this owner's manual are based on the latest product information available at the time of this publication. TVS Motor Company Limited may, however, incorporate modifications or improvements on its vehicles at any time without notice, and therefore, in such events it is possible that the relevant part of the owner's manual does not apply to your vehicle.

Prior permission of TVS Motor Company Limited is required for quoting, copying or reproducing any part of this owner's manual.

### Note

***Accessories shown in the picture may not be a part of standard equipment.***

*Pictures shown in the manual are of TVS RONIN with connected instrument cluster until otherwise specified.*

*Your motorcycle is provided with always glowing head lamp (AHO). The head lamp glows automatically once the engine is started.*

*Since your vehicle is fitted with side stand cut-off system ensure to retract the side stand before starting / moving the vehicle.*

The first 1000 km is a crucial part of your motorcycle. Proper running-in operation during this period helps in ensuring a **maximum life** and **smooth performance** of your motorcycle.

The reliability and performance of your motorcycle depends on the special care and restraint exercised during the running-in period. It is especially important that you avoid operating the engine in high speed (RPM), which could expose the engine parts to excessive stress. Recommended speed during the running-in is:

**Maximum 50 km/h speed upto 1000 km** (vary the engine speed for better mating of parts).

The first free service at 750 ~ 1000 km is most important. During running-in period all the engine components and other parts will have set in. All adjustments to be restored, all fasteners to be tightened. Engine cum transmission oil to be replaced. Timely performance of the first free service will ensure optimum service life and performance from the engine.



### Caution

*Replacing the engine cum transmission oil during first service is most important for better life of engine. Always use TVS TRU4 FULLY SYNTHETIC oil (SAE 10W30 API-SL, JASO MA2) for better performance and life.*

*Since your motorcycle is fitted with Evaporative Emission Control System, **the motorcycle should not be laid on the floor during water wash**. Else it may lead to difficulty in starting and improper running of the motorcycle.*

## ANTI-LOCK BRAKE SYSTEM (ABS)

Your motorcycle is fitted with an Anti-lock braking system (ABS) which is designed to prevent skidding and help riders to maintain steering control during emergency-stopping situation in dry or wet roads, loose gravels etc. In case of single channel ABS system, the ABS system is provided only on the front brake whereas dual channel system has the ABS system on both front and rear brakes.

### How does ABS work?

When a rider applies the front brake (in single channel system) or any of the brake (in dual channel system) continuously, as he detects a dangerous obstacle in dry or wet roads, loose gravels etc. transmits an excessive brake force to the wheels. This excessive force may cause the wheels to stop spinning and leads to loss of road grip. With no firm contact between the tire's contact patch and the road surface, the bike becomes unstable and a crash is imminent.

The slipping wheels on a riding surface results in losing control of whole motorcycle which usually occurs in fractions of a second. Restoring traction while keeping the bike balanced is only a result of luck, or extreme training, as is the case of professional stunt riders who drift. Preventing the wheels from slipping due to excessive braking force compensates losing control and help the rider to maneuver the vehicle and to avoid accidents.

So what the ABS does is actually limiting the braking force exerted by the rider by either squeezing the lever and keep the wheel spinning. Once the imminence of the locking (and therefore skidding) is avoided, the system re-applies the maximum braking force until the next skid is anticipated. By limiting the max force of the braking maneuver, the ABS systems practically allow the riders to use the greatest stopping force possible without locking the wheels.

### How does the ABS understand the wheel locking?

The ABS uses continuous wheel speed monitoring system; wheel speed sensors and toner rings and a Hydraulic Electronic Control Unit (HECU).

During normal operation the ABS works similar to a normal brake. The speed sensors fitted on the both the wheels (in case of dual channel ABS) measures the rotational speed of the wheels, when the wheel speed reduces rapidly i.e. wheels tends to lock, the HECU modulates the pressure in the brake circuit and thereby prevents the wheels from locking.

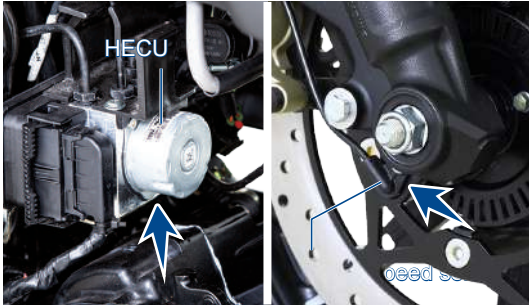

### How the irregular road surface affects the braking?

Humps and irregular surfaces of the road can cause the wheels to lose contact temporarily with the road surface; if this happens the braking force that can be transmitted to road surface is zero.

If the brakes are applied under these condition, the ABS has to reduce the braking force to ensure and maintain the directional stability when the wheels regains its contact with the road surface. At this instant the ABS must reduce the traction, so that the wheels will continue to rotate under all imaginable circumstances, because this is the precondition for ensuring directional stability.

As soon as the actual circumstances arises, the system reacts instantly and adjusts braking force accordingly to achieve optimum braking.

### Why does brake pedal / lever pulsate during brake application?

Vehicles fitted with ABS uses the conventional brake system during normal operation. **But during hard stop the brake pedal / lever feels different, i.e., a rapid pulsation in the brake pedal / lever; This is absolutely normal.**

It is not necessary to have this pulsation feel every time the brake is applied. Pulsations are felt only during wheel locking tendency, occurs due to the modulation of pressure in the brake circuit by HECU. Pulsation means that the vehicle is in limit. This pulsation feel also depends on the road condition.

### Rear wheel lift

Under very severe and sudden deceleration, however, under certain circumstances it is possible that the ABS unit fitted in your vehicle will be unable to prevent the rear wheel from lifting clear of the ground and flip over. Severe braking can cause the rear wheel to lift off the ground. When you brake, bear in mind that ABS control cannot always be relied on to prevent the rear wheel from lifting clear of ground.

## Warning

The ABS can apply and release the pressure in the brake circuit much faster than that rider can do with brake lever / pedal to avoid wheel locking. So there is no need to pump the brake, it requires only continuous application.

**In case of single channel ABS system, only the front brake of your motorcycle is fitted with ABS system and not the rear brake. Applying rear brake alone can cause wheel skidding just like normal braking system. Always apply both front and rear brake for better performance.**

## ABS warning lamp



The TVS RONIN does an automatic self check every time whenever the ignition lock of the bike is turned 'ON'. The ABS warning lamp provided on the instrument cluster blinks and informs you that the ABS is under check.

This ABS warning lamp goes 'OFF' once the bike reaches 10 km/h speed and above in dual channel ABS system and 6 km/h speed and above in single channel ABS system. This ABS warning lamp blinks whenever the bike speed goes below 6 km/h in single channel ABS system to indicate that the ABS system is working fine.

If the warning lamp glows continuously even after the bike crossing the specified speed limits, then the ABS has an error and your bike should be taken to any of our nearest TVS Motor Company Authorised Main dealer / Authorised Dealer for inspection.

## DO'S AND DONT'S

### Do's

- ◆ Check the ABS warning lamp for any warning before driving the vehicle.
- ◆ Apply both front and rear brake for better performance.
- ◆ Apply continuous brake for better performance. Do not pump.
- ◆ Perform the periodic maintenance as per the schedule.
- ◆ ABS should be serviced only at TVS Motor Company Authorised Main Dealer / Authorised Dealer.
- ◆ Carefully remove the wheels during puncture / tyre replacement to prevent toner ring damage / bend.
- ◆ **Keep the wheel in such a way that the toner ring is facing upwards.**

- ◆ Always use recommended brake fluid. Use fresh, clean brake fluid.
- ◆ Use only the recommended make, type and size of tyre (ABS tuned with tyre specified by the TVS Motor Company).

### Dont's

- ◆ Do not use **non-standard tyres.**
- ◆ Do not pump the brakes. Apply the brakes continuously.
- ◆ Do not ignore any warning lamp on speedometer.
- ◆ Do not adjust the wheel speed sensor air gap your self.

### Warning

*ABS helps only in improving the vehicle control. It is always good to remember not to exceed the physical limits of the vehicle stability. It is rider's responsibility to ride at a suitable speed, while taking care of conditions and road surface. ABS will not compensate for errors in the judgement or improper brake use in the various situation. ABS never eliminates the danger of falling while turning.*

*Hard braking during sharp cornering on slippery surface may lead to vehicle instability. Under such circumstances gradual braking is recommended.*

- ◆ Do not run the engine and ride or rotate the rear wheel alone in gear with vehicle on centre stand, for drive chain lubrication, during water wash etc.,
- ◆ Do not attempt to correct the toner ring teeth by bending manually or by using any other method.
- ◆ Do not use different toner ring.
- ◆ Do not insert any metallic parts near wheel speed sensor.

### Note

*Incase of ABS failure, the braking system will work like a non ABS braking system and provides normal stopping distance.*

*This motorcycle is equipped with ABS and tubeless tyres. For repair or replacement please contact nearest TVS Motor Company Authorised Main Dealer / Authorised Dealer.*

*As a general riding practice it is advisable to apply more front brake and less of rear brake.*

*Use of non-genuine brake pads, tyres, disc etc. leads to poor braking performance and unsafe riding conditions.*

*Never open HECU on your own, it is a very sensitive part of ABS and needs to be handled only by the trained personnel. Contact your nearest TVS Motor Company Authorised Main Dealer / Authorised Dealer.*

- ◆ Do not test the ABS on road!!, but use ABS (it is already tested).
- ◆ **Do not use non-genuine spares like pads, discs, tyres etc.**
- ◆ Do not try to service HECU or open to separate parts.
- ◆ Do not disengage the ABS by removing the ABS coupler.

### Warning

*Do not ride the vehicle in conditions like wheelie, stoppie, on-stand engine revving in gear for chain lubrication and during water wash etc... for more than three minutes as it will result in ABS error and ABS warning lamp glowing continuously. In such cases, just switch 'OFF' and switch 'ON' the ignition key once. ABS warning lamp may glow continuously if any ABS error had occurred before.*

*This error gets cleared automatically and ABS warning lamp goes 'OFF' after riding the vehicle above 6 km/h in single channel ABS and 10 km/h speed in dual channel ABS. If the ABS warning lamp is still 'ON', then contact the nearest TVS Motor Company Authorised Main Dealer / Authorised Dealer **(applicable only for dual channel ABS system)**.*



## SAFE RIDING RECOMMENDATIONS

Any two wheeler riding requires some precautions to be taken to ensure the safety of the rider, pillion rider and other road users. These precautions are:

### Familiarise yourself with new TVS RONIN motorcycle

Riding skill and your mechanical knowledge form the foundation of safe riding practices. We suggest you to practice riding TVS RONIN in a low-traffic condition until you are thoroughly familiar with your vehicle and its controls. Remember practice makes you perfect.

### Riding apparel

Loose, fancy clothing can be uncomfortable and unsafe when riding a two-wheeler. Choose good quality two wheeler riding apparel.

### Know your limits

Ride within the boundaries of your own skill at all times. Knowing these limits and staying within them will help you to avoid accidents.

### Warning

**Two wheeler safety starts with wearing a good quality helmet.** *One of the most serious injuries that can happen is a head injury. Always wear an ISI approved helmet that should fit your head comfortably and securely. You should also have good quality goggles to protect your eyes and help your vision.*

*To prevent or minimize accident, never consume alcohol or drugs before or during the operation of your vehicle. Even minimal consumption of these will affect the rider's ability to control the vehicle.*

## Posture

Proper vehicle riding starts with proper posture.

1. Sit erect on the seat at the position which you feel most comfortable.
2. Keep your arms relaxed to give extra cushion for body on uneven road surfaces.
3. Keep right arm and foot close to the brake lever and pedal, so as to enable fast action during panic braking.

## Warning

**One-hand riding is dangerous.** *Keep both hands firmly on the handle bar and both feet securely on the foot rest. Under no circumstances should both the hands be removed from the handle bar, as it is very dangerous.*

**Avoid use of mobile phones while riding as it could lead to fatal accident.**

*Do not downshift the gears in the midst of cornering. Slow down to a safe speed before negotiating a corner. If this is the first time that you are riding a vehicle of this type, we suggest that you practice on a safe, open area to thoroughly familiarise with the operation of the vehicle.*

4. Look widely instead of gazing at one point.
5. Alter your sitting location / posture slightly at intervals during long rides. This will reduce fatigue.

## Cornering

When cornering, centrifugal force works in a direction perpendicular to the direction in which the vehicle is moving. Centrifugal force increases in proportion with speed and the radius of the corner.

During cornering, reduce speed so as to reduce the effects of centrifugal force. Avoid abrupt application of brake or sudden steering by all means.

## Braking

For safe riding, it is very important to master the braking techniques.

1. Close / release the throttle.
2. Hold the vehicle upright as you apply the brake.
3. Progressive application of brakes is safer.
4. Never declutch while braking at higher speeds.
5. **Apply both the brakes.**
6. Do not pump the brakes.

- Riding down hills, while cornering and wet roads close throttle and down shift the gear to take advantage of gearbox and engine which acts as an additional brake. This will avoid the loss of control over the vehicle due to over speed.

### Causes for poor braking

- If the brake shoes / pads or drum / disc are worn out or if there is water or oil on them, sufficient friction does not develop and brakes do not work well.

### Warning

*As the vehicle speed increases, the stopping distance also increases progressively. Be sure that, you have sufficient distance between you and the vehicle or obstruction ahead of you.*

*Avoid directing the water jet directly towards brake drum / disc pads during water wash.*

*Using only the front or rear brake is dangerous and can cause skidding and loss of control. **Apply both the brakes together and with great care on a wet road or other slippery surfaces.***

*Any abrupt braking on slippery or irregular roads can cause loss of rider control.*

- Even when the brake works normally, if the road surface is wet or the tyre surface is worn-out, tyres do not take a firm hold on the surface, increasing the stopping distance.
- Approximately 60% braking effect is from front brake. **Non-usage of front brake causes poor braking.**

### ACCESSORY INSTALLATION AND SAFETY TIPS

Use extreme caution while selecting and installing the accessories for your motorcycle.

The addition of **unsuitable accessories can lead to unsafe operating conditions.** Your friendly Dealer will assist you in selecting quality accessories and installing them correctly.

While selecting the accessories, make sure the accessories **should not obstruct lighting, steerability, suspension level and ground clearance.** Please ensure that, if the tank cover is used, it is not getting en-trapped between fuel tank and fuel tank cap.

**Additional electrical equipments is not acceptable as it will void the warranty terms of the vehicle.**

## EMISSION CONTROL

All the TVS vehicles are tested in the factory for optimum fuel efficiency and CO levels. If the vehicle needs any adjustments, please consult nearest TVS Motor Company Authorised Main Dealer / Authorised Dealer.

While adequate care is exercised at the factory to ensure that the emissions are within the limits, it is essential for the owner to always maintain the motorcycle in good condition by getting it periodically checked and serviced by TVS Motor Company Authorised Main Dealer / Authorised Dealer so that the emission and fuel consumption levels are maintained as per norms.

### Crankcase emission control system

The engine of new TVS RONIN is equipped with a closed crankcase system to prevent discharging crankcase emissions into the atmosphere. Blow-by gas is returned to the combustion chamber through the air cleaner.

### Evaporative Emission Control System

The TVS RONIN is equipped with an evaporative emission control system which consists of a canister and associated piping. This system prevents the escape of fuel vapors from the fuel tank.

### Warning

*If there is any abnormal jerk, startability issue are felt in the vehicle or noise due to sudden escape of gas during opening of fuel tank cap, immediately report to the TVS Motor Company Authorised Main Dealer / Authorised Dealer.*

### Note

***Your vehicle is tested and certified for emission which meets BSVI emission norms and is valid for initial 12 months from the date of purchase. Get your vehicle certified by the Government authorised emission testing station after initial 12 months of usage. And ensure to get the vehicle certified on expiry of the certificate obtained.***

## VEHICLE IDENTIFICATION NUMBER

The frame and engine serial numbers are the only means of identifying your vehicle from others of the same model and type. They are also required to assist your Dealer for ordering parts or referring to special information.



Frame serial number is engraved on the frame below the seat assembly as shown.



Engine serial number is engraved on the left side crankcase assembly near cylinder block as shown.

## LOCATION OF PARTS - HANDLE BAR

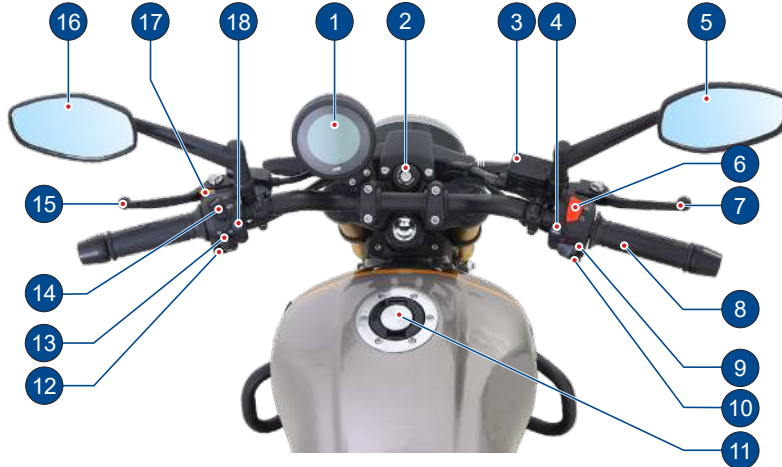

1. Instrument cluster
2. Ignition cum steering lock
3. Master cylinder (front)
4. Mode switch
5. Rear view mirror R
6. Engine cut off switch
7. Front brake lever
8. Throttle grip
9. Hazard switch
10. Electric starter switch
11. Fuel tank cap
12. Horn switch
13. Turn signal lamp switch
14. High / low beam switch
15. Clutch lever
16. Rear view mirror L
17. Pass-by switch
18. Info switch\*

\* Applicable for Connected instrument cluster version only

**LOCATION OF PARTS - VEHICLE LEFT SIDE**

1. Front wheel axle
2. Gear shift lever
3. Side stand
4. Rider foot rest L
5. Center stand
6. Chain inspection window
7. Pillion foot rest L
8. Rear wheel axle
9. Reflex reflector
10. Cover frame L

## LOCATION OF PARTS - VEHICLE RIGHT SIDE



1. Disc plate front
2. Toner ring front
3. Front wheel axle nut
4. Wheel speed sensor front
5. Caliper assembly front
6. Location of spark plug
7. Gauge oil level
8. Rear brake pedal
9. Rider foot rest R
10. Master cylinder rear
11. Oil reservoir rear
12. Pillion foot rest R
13. Muffler assembly
14. Disc plate rear
15. Wheel speed sensor rear\*
16. Caliper assembly rear
17. Reflex reflector
18. Cover frame R

\* Applicable for Dual channel ABS version only



## LOCATION OF PARTS - VEHICLE FRONT & REAR

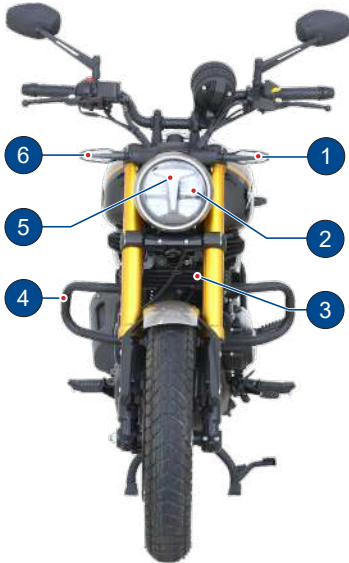

### FRONT

1. Turn signal lamp front L
2. LED Head lamp assembly
3. Oil cooler
4. Tank guard
5. Position lamp
6. Turn signal lamp front R

### REAR

1. Turn signal lamp rear R
2. Reflex reflector
3. Number plate lamp
4. Turn signal lamp rear L
5. Tail lamp assembly
6. Pillion handle

*License plates are mandatory accessory will be charged extra*

## CONTROL KEY

TVS RONIN comes with a pair of identical control keys. These keys are to operate ignition cum steering lock, fuel tank cap and seat lock.

## IGNITION CUM STEERING LOCK

The ignition cum steering lock enables and disables the electrical circuit and steering lock. There are three positions in the ignition cum steering lock. They are:

### 1. 'OFF' position

All the electrical circuits are turned 'OFF' in this position. Engine will not start. Key can be taken out.

### 2. 'ON' position

In this position, all the electrical circuits are turned 'ON' and the engine can be started. The instrument cluster and warning lights performs self-diagnostic cycle. Key cannot be removed.

## Note

*When the ignition is turned 'ON' with the engine kill switch 'ON' condition, priming noise of pump may be heard which is absolutely normal. Frequent switch 'OFF & ON' of ignition to be avoided to prevent unnecessary run of fuel pump. After ignition lock reset, there may be a delay in start of vehicle for couple of seconds.*



### 3. 'LOCK' position

TVS RONIN's steering can be locked in both 'left' and 'right' directions. To lock the steering, turn the handlebar all the way to the 'left' or 'right' direction. Push the key 'IN' and turn it to the 'LOCK' position and take out. All the electrical circuits are turned 'OFF' in this position. Insert the control key into the lock, push the key 'IN' and turn it to 'OFF' or 'ON' position to unlock the steering.

## Warning

*Never attempt to move the vehicle when the steering is locked, you may lose balance. Always lock the steering while parking for safety.*

## Caution

Before turning the ignition key to 'ON' position, ensure the availability of adequate fuel in the tank **to avoid dry run of fuel pump**. Fuel level always to be maintained above empty indication (Low fuel indication icon glow). **Never run the fuel pump dry to avoid failure of fuel pump.**

Leaving the ignition cum steering lock in 'ON' position for a prolonged time will drain the battery when the vehicle is not in use. Switch 'OFF' and take the key out when the vehicle is not in use.

## Note

Instrument cluster's background illumination, front position lamp (FPL), tail lamp and number plate lamp glow automatically once the ignition is turned 'ON' without activating any other switch.

When the ignition switch is turned 'ON', the instrument cluster performs a self check and the details like 'ride mode', 'ODO' will be displayed in the cluster's display. In case of connected instrument cluster, the cluster displays the product name 'RONIN' followed by a greeting message 'HAVE A SAFE RIDE' will be displayed. Wait till the cluster's display becomes static.

## HANDLE BAR LEFT SIDE

### 1. Info switch\*

Info switch '

### 2. Turn signal lamp switch

Slide the turn signal lamp switch to left '

### 3. Horn switch

Press the switch () to blow horn. It is used to attract the attention of other road users in case of danger.

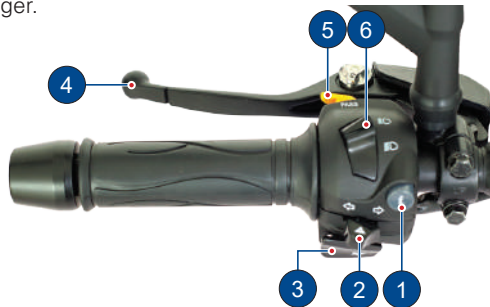

\* Applicable for Connected instrument cluster version only

### **Warning**

*Failure to switch the turn signal lamp 'ON' or 'OFF' at the right time may lead to an accident.*

### **4. Adjustable clutch lever**

Use the clutch lever to disengage the drive to the rear wheel while shifting the gears. Squeezing the lever towards grip disengages the drive.

### **5. Pass-by switch**

Press the switch to flash the head lamp high beam. It is used to give signal to the vehicles coming from the opposite direction while overtaking other vehicles during day.

The pass-by works only when the head lamp is glowing in low beam. If the switch is pressed while the head lamp is glowing in high beam, there will be no change in beam of head lamp.



### **Note**

*Clutch lever position can be set to your convenience. Refer page no. 74 for details.\**

*Pass by system will not work if the head lamp is glowing in 'High' beam.*

### **6. Head lamp high / low beam switch**

The head lamp low beam glows (low or high beam glows based on the switch position) automatically on starting the engine. The head lamp beam (high/low), can be controlled using the beam control switch.

Press the top end of switch for 'High' beam '  ' and bottom end for 'Low' beam '  '.

### **Warning**

*Use appropriate head lamp beam 'high / low' as per the traffic and road conditions for your safety and to avoid inconvenience to other riders.*

*It is strongly recommended to ride the vehicle in 'low' beam during day.*

### **Note**

*The headlamp glows in low beam / high beam automatically once the engine is started based on the position of beam control switch.*

*\* Applicable for Connected instrument cluster version only*

## HANDLE BAR RIGHT SIDE

### 1. Engine cut off switch

It is used to switch off the engine but to keep other DC system active. If the switch is positioned at '❌', the ignition circuit will be disabled, preventing the engine from being restarted. To restart the engine, return the switch to the '🔄' position.

### 2. Adjustable front brake lever

It controls a hydraulic circuit (ABS) that operates the front brake system. The front brake is applied by pressing the front brake lever gently towards the grip. The brake lamp glows on application of front brake

### 3. Throttle grip

It controls the fuel-air mixture supplied to the engine, which regulates the engine speed. Rotate the throttle grip in counter-clockwise from its idle position to increase the engine speed and vice-versa to reduce.

### 4. Electric starter switch

Press the electric starter switch '🔄' to start the engine. Ensure the transmission is in neutral or else press the clutch lever completely and side stand is retracted before engaging the electric starter switch.

\* Applicable for Connected instrument cluster version only



### Note

Ensure to turn 'ON' the engine cut-off switch before starting the vehicle. Release the electric starter switch immediately after pressing.

Front brake lever position can be set to your convenience. Refer page no. 74 for details.\*

### Caution

Operation of electric start switch with clutch lever not in completely pressed position can lead to jerking of the vehicle, to prevent such unexpected behavior it is recommended to press the clutch lever completely.

## 5. Hazard switch

Whenever it is necessary to park the vehicle in a hazardous location due to emergency situation, press the hazard switch to '▲' position with the ignition 'ON' condition. This makes all the turn signal lamps to flash simultaneously to make other road users aware of presence of the vehicle.

### Warning

*Usage of hazard switch in engine 'OFF' condition can lead to battery drain and can affect the electric startability of the vehicle.*

## 6. Mode switch

Press the mode switch to switch between 'Urban' and 'Rain' modes (refer page no. 36).

## GEAR SHIFT LEVER

TVS RONIN is equipped with a 5 speed constant mesh transmission. Neutral (N) position of the transmission is indicated by the indication light 'N' on the instrument cluster.

To shift the transmission from neutral to first gear, push the gear shift lever down. To change it to the second gear, lift the lever up.

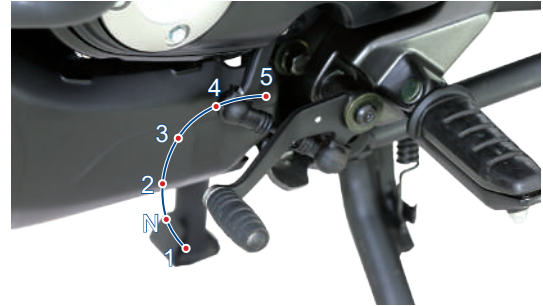

Lifting the lever up repeatedly engages all the gears in succession up to the fifth gear.

The gear shift indicator on the speedometer display indicates the current gear position.



UP SHIFT



DOWN SHIFT

### Caution

*Never shift gears without disengaging the clutch and releasing the throttle. Failure to comply will lead to rough shift or jerk while shifting the gears. Remember to return to neutral position before restarting the engine or when in gear disengage the clutch to restart the engine.*

## REAR BRAKE PEDAL

The rear brake pedal operates a hydraulic circuit (ABS circuit incase of Dual channel ABS) that operates the rear brake system and it is located adjacent to the right side foot rest. To control the speed of your vehicle close the throttle completely and press the brake pedal down wards gradually.

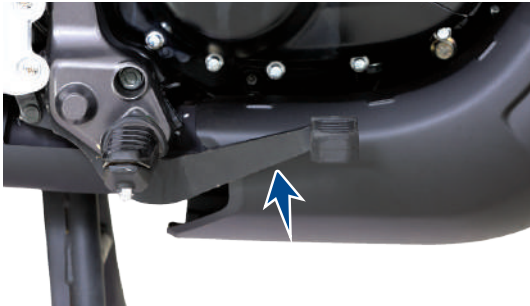

### Caution

*Independent use of rear or front brake reduces the overall braking efficiency. In extreme conditions braking with only rear or front brake may lock the wheel which would result in skidding or toppling of vehicle.*

*Braking performance is affected adversely with wet surfaces, loose surfaces and overheating of brake system due to unnecessary continuous application of brakes. For safety, exercise extreme caution while braking and also at turning. Do not accelerate while turning.*

## INSTRUMENT CLUSTER

Your TVS RONIN is provided with a fully digital instrument cluster with lots of features and various modes. The connected type instrument cluster has the mobile app for 'Smart Phones' and navigation assist etc. The non-connected type comes without mobile app and navigation assist.

### Connected Type



### Non-Connected Type



#### 1. Neutral indicator lamp ( N )

Glows when the vehicle is in neutral and goes 'OFF' if the gear is shifted from neutral.

#### 2. Malfunction indicator lamp ( MIL )

Malfunction indicator lamp (MIL) '  ' will be activated whenever the ignition is turned 'ON', till the engine is started. It will go 'OFF' once the engine is started.



If this lamp glows continuously even after starting the engine, it indicates that there may be an error in the system. **Contact the nearest TVS Motor Company Authorised Main Dealer / Authorised Dealer immediately for rectification.**

### 3. Turn signal indicator left ( ← )

Flashes when the left side turn signal indication is activated.

### 4. Low fuel indication ( )

Low fuel indicator blinks to alert the rider that fuel has reached below recommended level and continuous glow indicates that fuel is empty which will hamper continuous operation of vehicle.

### 5. High beam indicator lamp ( )

Glow when the head lamp is activated in high beam.

### 6. Immobilizer indicator ( )

-NA-

### 7. ISG malfunction indicator ( )

ISG malfunction indicator will be turned 'ON' when there is a fault in the ISG system.

If the ISG malfunction indicator is glowing continually after the self check cycle of the speedometer, contact the nearest TVS Motor Company Authorised Dealer / Authorised Dealer immediately for rectification.

### 8. Turn signal indicator right ( → )

Flashes when the 'right' side turn signal indication is activated.

### 9. Side stand indicator ( )

The side stand warning indicator turns 'ON' to alert you whenever the vehicle's side stand is 'ON'.

### Note

*In geared condition, if the side stand is deployed, the vehicle will not start. In neutral condition, if the side stand is deployed, the vehicle will start, but gets off immediately once the gear is engaged.*

*If there is an error in the side stand sensor, the side stand indicator start to blink and the vehicle will not get start. In such a condition, please visit the nearest TVS Motor Company Authorised Main Dealer / Authorised Dealer.*

NA - Not applicable for present model

### 10. ABS warning lamp ( )

ABS warning lamp blinks when the ignition key is turned 'ON' and speedometer performing self check. This lamp goes 'OFF' once the vehicle reaches 10 km/h speed and above in dual channel vehicle and 6 km/h speed and above in single channel vehicle. If this lamp glows continuously even after reaching the specified speed, have your vehicle checked at TVS Motor Company Authorised Main Dealer / Authorised Dealer (refer page no. 11 for more details).

#### Note

*In single channel ABS vehicle, the ABS warning lamp will be blinking whenever the vehicle speed is less than 6 km/h during the ride which is normal. It indicates that the ABS is working fine and no need of any inspection.*

11. Gear shift indicator / 12. Tachometer / 13. Digital clock / 14. Speedometer / 15. ODO - TRIP A & B - DTE indicator / 16. Fuel gauge

#### Connected Type



#### Non-Connected Type



## 11. Gear shift indicator

The gear shift indicator in the digital display indicates the position of the gears.



Gear shift indicator also alerts the user to 'up shift' or 'down shift' the gears when the engine reaches specified RPM based on the ride modes and smooth engine operation.



UP SHIFT



DOWN SHIFT

When no shift indication is available, it indicates your present operating condition is in optimal range for the said gear

### Note

The shift indicator does not work when the vehicle is in neutral (after vehicle reached standstill condition), up shift indication will not work once the fifth gear is engaged and down shift condition will not work once the first gear is engaged.

## 12. Tachometer

Tachometer indicates the engine speed in multiples of 1000 RPM (Revolutions Per Minute).

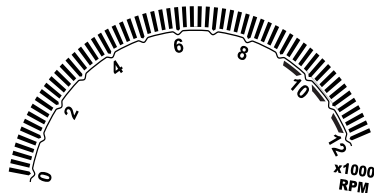

## 13. Digital clock

Indicates the time in 12 or 24 hour time format as per user's preferred setting. Refer page no. 40 for changing the time format to 12 hour or 24 hours.



### Note

If the battery is disconnected and reconnected during service. You may need to reset the time as explained in page no. 40. In case of connected instrument cluster, the time get set automatically on connecting it with the mobile app.

## 14. Speedometer

**100** km/h

Indicates the vehicle speed in kilometer per hour (based on factory setting).

### Note

*If you notice an error message '- -' instead of speed indication when the vehicle is in move, Contact nearest TVS Motor Company Authorised Main Dealer / Authorised Dealer.*

## 15. ODO - Trip A & B - DTE indicators

The procedure for setting 'ODO', 'TRIP A & B' and 'DTE' modes is given in page no. 38.

### 15a. Odometer

Odometer registers the total distance covered by the vehicle in kilometer. Set the meter in 'ODO' mode to know the odometer reading.

**ODO**                      **153** km

### Note

*Incase of single channel ABS vehicle ODO mode will be displayed always. No need to set the ODO mode.*

### 15b. Trip meter A & B

Trip meter indicates the trip distance travelled in kilometers. The digit after the dot mark denotes the one tenth of a kilometer.

Provision to measure two different distance 'TRIP A' or 'TRIP B' is provided for the users to use as per their convenience.

**TRIP A**                      **56.4** km

**TRIP B**                      **86.2** km

### 15c. Distance to empty (DTE)

Indicates the approximate distance that can be covered by the vehicle with the available fuel in the tank.

DTE value will be shown only when fuel bar is between 1 to 8 and in LFI blink condition. In empty and 9 bar condition '- -' will be displayed. In addition to above conditions in which DTE cannot be calculated not limited to fuel sensor error '- -' will be displayed.

**DTE**                      **38** km

## Note

*DTE is an estimated measure of distance that can be travelled and it is subjected to variation based on riding pattern, road conditions etc. DTE should be used only as indicative parameter for next refilling point, not in the absolute sense.*

### 16. Fuel gauge

Digital bars indicates the approximate quantity of fuel available in the fuel tank. There are nine bars to indicate the quantity of fuel available in the fuel tank.



All the nine bars will be displayed when the fuel in the tank reaches above 10.3 liters approximately (full tank).

When the fuel reaches half tank (6.1 liters approx.) the fuel gauge displays only four bars as shown.



## Note

*When the ignition switch is turned 'ON' with the engine kill switch 'ON' condition, priming noise of fuel pump may be heard which is absolutely normal. Frequent switch 'OFF & ON' of ignition to be avoided to prevent unnecessary run of fuel pump.*

The fuel gauge shows only single bar when the fuel reaches safe fuel level (3.2 liters approx.).



Low fuel indication (serial no. 4) starts blinking when no bar is visible the fuel reaches to the minimum safe level 2.6 liters approximately. Refill the fuel immediately. Once the fuel level reaches 2 liters approximately, no bar will be visible and low fuel indication (serial no. 4) glows continuously.



If all the fuel level bars in the cluster are blinking, contact nearest TVS Motor Company Authorised Main Dealer / Authorised Dealer.

**17. Low battery indicator (only in non-connected type cluster)**

An icon with battery symbol ‘’ glows when the battery charge is too low. Get the battery checked at TVS Motor Company Authorised Main Dealer / Authorised Dealer.

**18. Service reminder (only in non-connected type cluster)**

If the service is due, whenever the ignition lock is turned ‘ON’, an icon with spanner symbol ‘’ blinks for 10 seconds after the speedometer’s self check and continues to glow till the vehicle is serviced and reset. Get the vehicle serviced at TVS Motor Company Authorised Main Dealer / Authorised Dealer.

**Note**

*Service reminder works only based on the distance (km) covered by the vehicle. This is only a reminder indicator. Customers are advised to keep track and follow the service schedule.*

**19. Notification area (only in connected type cluster)**

A general purpose notification area where ride mode information, error message, service due, connectivity information and warnings are displayed.



**19a. Service reminder**

If the service is due, whenever the ignition lock is turned ‘ON’, the following message will be popped-up after the speedometer’s self diagnostic cycle and continues to pop-up till the vehicle is serviced and the reminder is reset. Get the vehicle serviced at TVS Motor Company Authorised Main Dealer / Authorised Dealer.



### Note

Service reminder works only based on the distance (km/miles) covered by the vehicle. This is only a reminder indicator. Customers are advised to keep track and follow the service schedule.

### 19b. Low battery indicator

The following message will be popped-up after the speedometer's self diagnostic cycle when the battery charge is too low. Get the battery checked at TVS Motor Company Authorised Main Dealer / Authorised Dealer.



### Note

Service reminder and battery low pop-ups can be cancelled by pressing the 'Info switch (  )' on the handle bar.

## 20. Ride Modes

TVS RONIN has two different ride modes, select the desired ride mode by pressing the mode switch in the right hand switch assembly (refer page no. 26) or by pressing the mode switch of the instrument cluster.

The two ride modes are:

20a. URBAN

20b. RAIN

These ride modes and its sequence are explained below:

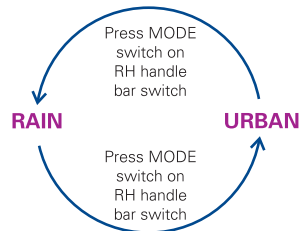

The preferences of mode usage are:

- 'Urban' mode - for city and highway.
- 'Rain' mode - for wet and mud roads.

**20a. URBAN mode**



In 'Urban' mode the ABS braking system is modified to suit city on all types of roads riding condition. The ABS braking system is optimized accordingly.

**20b. RAIN mode**



In 'Rain' mode the ABS braking system is modified to suit wet or rainy condition. The ABS intervention is earlier and safe braking will be felt.

 **Note**

*At the end of self-check active ride mode information will be displayed on the LCD segment.*

*Mode changes are effected only when the throttle is closed after a mode change request. To guide you to do the same,*

- *A message 'CLOSE THROTTLE' will be popped-up in the notification area of the connected instrument cluster.*

**CLOSETHROTTLE**

- *A message 'Cl trl' will be displayed in the odometer display area of the non-connected instrument cluster.*

**C I E T I**



## MODE AND SET BUTTONS

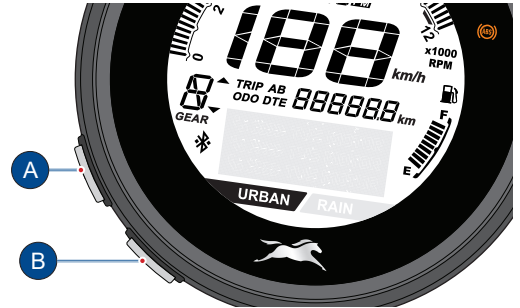

The 'Mode' (A) and 'Set' (B) buttons are provided to change between various modes and to set the some of the digital display functions of the instrument cluster. The sequence of modes and their selections are explained in detail below.

Short press the Mode button to access the following modes:

1. ODO\*
2. TRIP A
3. TRIP B
4. DTE

## Note

In case any fault is detected with respect to the ride mode change in the EMS or ABS system, then your motorcycle will operate only in the 'Urban' mode after ignition key reset.

If conditions for mode change are not successful,

- A message 'MODE CHANGE ERROR' will be popped-up in the notification area of the connected instrument cluster.
- A message 'Ch Err' will be displayed in the odo meter display area of the non-connected instrument cluster.

## MODE CHANGE ERROR

Ch Err

\* Applicable for Connected instrument cluster version only

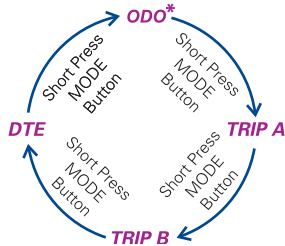

On long pressing the Mode button on any mode, the following modes can be accessed.

1. Clock setting
2. BT Pairing\*
3. Illumination setting

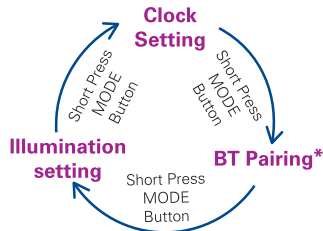

\* Applicable for Connected instrument cluster version only

## Setting the digital display

Every press of the 'Mode' button changes the display to other mode. Follow the below procedures to change the display to desired mode.

If ignition is turned 'OFF' when the meter is in 'ODO' or 'TRIP' meters, then the respective meters will be displayed in the next ignition 'ON'.

1. In 'ODO' mode, press the 'Mode' button once and twice to enter ' <sup>TRIP A</sup> 56.4 km ' and ' <sup>TRIP B</sup> 86.2 km ' meters respectively.
  - To reset any of the trip meter while ensuring the display is in 'TRIP A' or 'TRIP B', press and hold the 'Set' button for a few seconds.
2. In 'TRIP B' meter mode, press the 'Mode' button once to enter 'DTE' mode.
  - To reset 'DTE', press and hold the 'Set' button for a few seconds.

## Clock setting

1. The display can be in any screen.
2. Press and hold the 'Mode' button for few seconds till the display enters 'CLOCK SETTING'.
3. Press the 'Set' button to enter clock setting mode.
4. Now press 'Mode' button to change the clock to '⊙ 12Hr' 12 hours format or '⊙ 24Hr' 24 hours format.
5. Press the 'Set' button to set 12 hours or 24 hours format, if the clock is in 12 hours format, the hour format 'AM' or 'PM' blinks. Else the clock hours digit of the clock blinks.
6. Press the 'Mode' button to change the hour format 'AM' or 'PM' in 12 hour mode.
7. Press the 'Set' button to set AM or PM and now the hours digit of the clock blinks.
8. Now, press the 'Mode' button to increase the hours while hour digits are blinking.
9. On pressing the 'Set' button again the hours of the clock is set and the minute digit blinks.
10. Now, press the 'Mode' button to increase the minutes while minute digits are blinking.

11. Press the 'Set' button again to set minutes and to come out from clock setting.

### Note

*The clock time gets synced automatically on pairing your smart phone with the connected instrument cluster provided.*

## CONNECTED TYPE CLUSTER - FEATURES

### Bluetooth pairing mode ' '

Using the Bluetooth pairing mode the connected instrument cluster of 'TVS RONIN' can be connected to your Android™ smart phones and iPhone® via Bluetooth® through a TVS CONNECT app which can be download from Google Play and the Apple store®.



**TVS CONNECT**

### Note

*Depending on the make and Operating system of smartphone, only one phone can be paired with a single instrument cluster at a time. If the user need to connect multiple Phones with the single instrument cluster, the previous connected phone has to be forgotten by clicking, 'Forget This Device' from Bluetooth settings in the Phone. Also ensure to forget the instrument cluster from the local application memory.*

*If the vehicle battery is reset or fuse is blown, there is a possibility of failed Bluetooth connection, then too "Forget This Device" from Bluetooth settings in the Phone has to be done.*

## Steps to 'Forget This Device' in iPhone:

If the user needs to connect multiple iPhones with the single instrument cluster, the previous iPhone has to be forgotten using 'Forget This Device' from Bluetooth settings in the following manner:

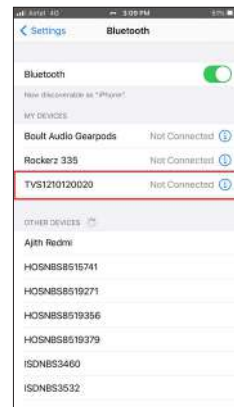

1. In the previous System connected iPhone, open the SETTINGS -> BLUETOOTH.
2. Select the instrument cluster, which was connected previously.
3. Click on the 'Forget this device'.

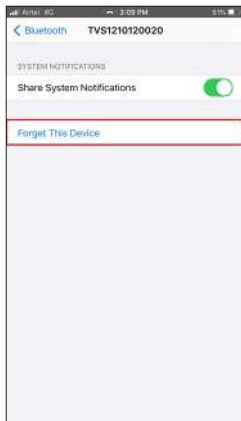

### Steps to 'unpair' in android Phone:

If the user needs to connect multiple android Phones with the single instrument cluster, the previous android Phone has to be forgotten using 'unpair' from Bluetooth settings in the following manner:

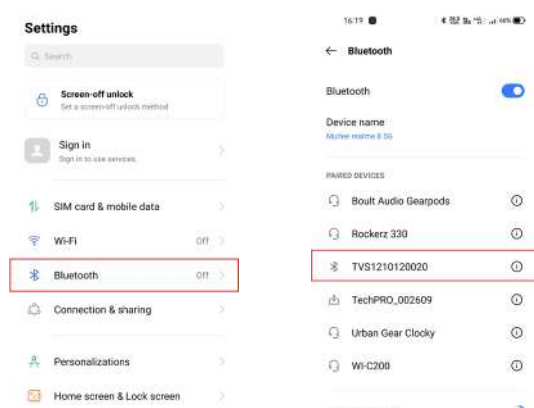

1. In the previous connected android Phone, open the SETTINGS -> BLUETOOTH.
2. Select the instrument cluster, which was connected previously.
3. Click on the 'Unpair'.



### First time Bluetooth pairing:

To pair your Android smart phone or iPhone with your TVS RONIN motorcycle's connected instrument cluster, via Bluetooth, for the first time, follow the procedure as described below:

- Press and hold the 'Mode' button for few seconds till the display enters 'CLOCK SETTING' mode'.
- Release and press the 'Mode' button one time so that the display enters '**BT PAIRING**' mode.

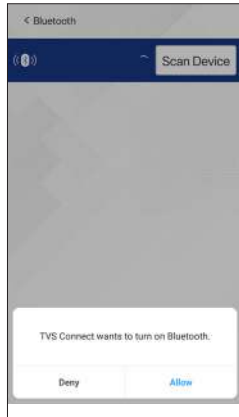

- After entering the BT pairing mode, open the mobile app and just press the 'Connect icon' of the mobile app to establish the connection with the cluster.
- On pressing this icon, the app opens a screen where you will be asked to grant permission to turn 'ON' your smart phone's Bluetooth if it is in 'OFF' condition. Turn 'ON' the Bluetooth.
- Else, press the 'Scan Device' icon to initiate the search in case the app is not searching automatically.
- The app searches and lists the available clusters. Just select the listed cluster. The app communicates with the cluster and the cluster generates a pass key.

Enter this pass key in the app screen to complete the connection.

**PASS KEY:123456**

 **Note**

*For the first time pairing, the connected instrument cluster should be in 'BLUETOOTH PAIRING MODE'.*

*During the course of pairing process, there is any occurrence of error, the connected instrument cluster should be turned 'OFF' and 'ON', and the application also need to be restarted.*

*Please remember that, all the smart phones are not compatible for pairing with the TVS RONIN motorcycle's connected instrument cluster.*

*During the search of Bluetooth devices in app, if the vehicle connected instrument cluster's Bluetooth device ID is not visible, try for one or two more iterations, along with forget device from bluetooth history as explained earlier.*

*If the phone enters battery saver mode, auto-pairing during active connected ride might not happen. It takes maximum of five minutes for auto-pairing and it can happen in vehicle running below 10 km/h speed or engine at idling or engine off condition.*

If the pass key entered wrongly then the instrument cluster displays the following message.

**PASS KEYWRONG**

On connecting with the smart phone successfully, the instrument cluster displays.

**BT CONNECTED**

 **Note**

*Auto-pairing happens in active connected rides only if the application is locked in the RAM in multitasking screen of the phone with manufacturer's customised OS (Ex. : MI, Vivo etc.).*

*In case of Android phones with Android OS version above 8.0 for App to work seamlessly, any battery optimisation setting to be removed in the TVS Connect app and GPS shall be allowed to run in background in high accuracy mode.*

*Even if your phone's Bluetooth is already paired to other gadgets like smart watch, health band or helmet, the auto-pairing works with your TVS RONIN motorcycle's connected instrument cluster.*





*If the application unfortunately stops due to unforeseen circumstances, Close and reopen the application and do connection process. Try for one or two more iterations, along with Bluetooth forgetting steps as explained earlier.*

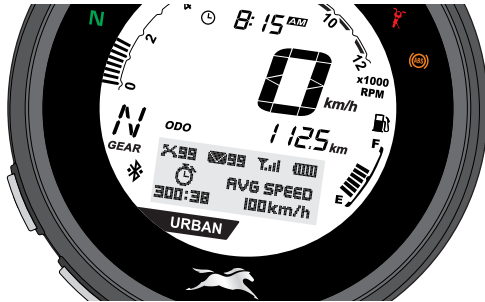

## Customer window

This is the default window when the connected instrument cluster of your 'TVS RONIN' is connected with your smart phone using Bluetooth .



Once the cluster is connected with the smart phone the cluster displays the signal strength of the network provider '  ' (depending on OS version) and the battery level '  ' of the smart phone. Number of unread messages '  6 ' for that particular ride and number of missed calls '  5 ' for that particular ride.

## Note

*Incase multiple SIM cards are used in smart phone, by default, SIM 1's network provider's signal strength is shown in the display of connected instrument cluster.*

*Signal strength displayed in connected instrument cluster might vary from the display in smart phone as the former is referred from telephonic standards.*

## Incoming call alert display ( )

The connected instrument cluster will display the incoming calls alerts from the smart phone via Bluetooth. Ex. 'AKASH', will be displayed if the contact is stored in the smart phone otherwise number will be displayed. Ex. '9897712345'.



## Note

*Call accept possible by doing a long press of info button. Incoming calls alerts can be cancelled by pressing the 'Info switch' (  ) on the handle bar.*

## Warning

*TVS Motor Company Limited does not recommend usage of any type of Mobile Hand Held Devices, and applications / features whether installed or associated with the vehicle which deprives the rider's attention and focus while riding the Two Wheeler. The customers and riders are strictly advised to understand the applicable laws, road safety Rules and the local laws on usage of electronic devices while operating the vehicle. Usage of any Mobile or hand held devices, and / or applications / features while riding the vehicle is totally at customer's / rider's risk. The product and features have technical limitations and are for general overview only.*

## Navigation window

Once the navigation assist is turned 'ON', the display of your TVS RONIN motorcycle's connected instrument cluster enters into navigation window and displays the turn by turn navigation instruction with a simple, elegant graphical representation and estimated time of arrival to the destination.

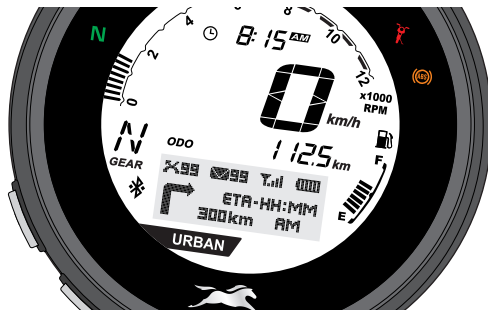

## Note

*Please remember that the Navigation License has to be renewed after 5 years of vehicle purchase and renewal can be done by contacting near by Dealer end.*

### Low fuel alert

When the fuel level in the vehicle reached below reserve level, the app sends a low fuel alert to the cluster to give notification of the fuel level. The same alert will be also shown in the app.

### Low fuel assist \ Nearest location alert

When the fuel level is low, the app sends a fuel assist message to the cluster. You can either accept or reject the assist request.

If you accept the request (by pressing the 'Info switch' on handle bar for about 3 secs.) the app will initiate navigation progress to the nearest fuel pump.



The customer also can chose to reject the request (by pressing the 'Info switch' on the handle bar for about 1 sec.). In which case, the previous display will remain.

### Clock auto sync

Whenever the app is connected to the connected instrument cluster the clock of instrument cluster gets synchronised with the clock of the phone.

## Voice assist

The connected functionality has come with an additional feature - Voice assistant. With help of the voice assist feature, the rider will be able to access mobile application and instrument cluster through speech. Once the mobile application is connected to the instrument cluster, voice assist feature can be used

There are two ways to invoke voice assist in your vehicle:

1. By pressing the Info switch for >3s, when the notification area is displaying customer window.
2. By pressing the voice assist icon in the app live dashboard or in other mobile application screens.
3. After invoking voice assist through either of the two ways, "Listening" will appear on the screen and a "speak now" will be heard on the headset.

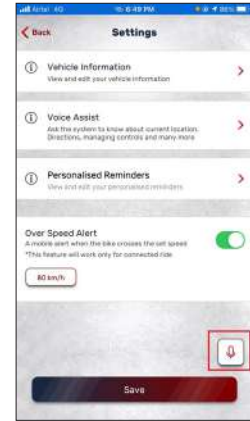

## Note

*Voice assist will work with screen lock condition / app background condition (depending upon smart phone's OS restrictions).*

*Use Wired / Wireless earphones for listening and talking.*

*Voice feedback will work only if a wired / wireless headphone is connected.*

*Option to enable/disable voice assistant and voice feedback is available in App settings.*

Wait for a second and start speaking/providing the command, once you hear "Speak now".

The following are the list of intents recognized by voice assist. You can refer page no. 51 for sample commands of each intent:

- Greeting command
- Navigation command
- Reset trip meters
- Reset DTE
- Switch to DTE screen
- Nearest POI command
- Current location
- Last call
- Enable / Disable High Speed Alert
- Ride start time
- Volume increase / decrease
- Brightness increase / decrease

## Voice assist commands and key words

S. No.	Intent	Commands	Voice Feedback
1	GREETING	Hi buddie	Hello '____'
		How are you doing	
		Hi buddie	
		Hey buddie	
		Hello friend	
		How u doing	
2	NAVIGATION	Go to	Taking you to '____'
		Take me to	
		Let's go to	
		Navigate to	
		Navigate me to	
		Guide me to	
		Show me	
		Take to	
		Directions to	
		Show me Directions to	

S. No.	Intent	Commands	Voice Feedback
3	RESET TRIP A MODE	Reset TRIP A	Trip A Mode Reset Complete
		Reset TRIP A Data	
		Reset Trip A Info	
		Erase Trip A	
		Clear Trip A	
		Clear Trip A Data	
4	RESET TRIP B MODE	Reset TRIP B	Trip B Mode Reset Complete
		Reset TRIP B Data	
		Reset Trip B Info	
		Erase Trip B	
		Clear Trip B	
		Clear Trip B Data	

S. No.	Intent	Commands	Voice Feedback
5	DTE MODE	Show my vehicle Range	DTE Mode Activated
		Show my fuel range	
		How far I can travel	
		Switch to DTE	
		Activate DTE mode	
		Switch to DTE mode	
6	RESET DTE MODE	Reset DTE	DTE Reset Complete
		Reset DTE Data	
		Reset DTE Info	
		Erase DTE	
		Clear DTE	
		Reset Range	
		Clear Range	
		Erase Range	



S. No.	Intent	Commands	Voice Feedback
7	POI	Near	Taking you to nearest ' ____ '
		Near by	
		Near to	
		Nearest	
8	CURRENT LOCATION	My location	You are around ' ____ '
		What is the name of this place	
		Where am i now	
		What is my current location	
		Show my location	
		Show my current location	
		Show current location	
		Show location	
Where are we right now			

S. No.	Intent	Commands	Voice Feedback
9	CALL LAST	Last call	You have last call from ' ____ '
		Who called me last	
		Who called recently	
		Last caller	
		Show my last caller	
		Who is my last caller	
10	RIDE START TIME	When did I start my ride	Ride Time ' ____ '
		What time I start ride	
		When did we start from home / work	
		Ride start time	
		Show start time	
		Show ride start time	
		Start time of ride	
11	VOLUME INCREASE	Increase volume	Volume Increased
		Volume up	
		Increase sound	

S. No.	Intent	Commands	Voice Feedback
12	VOLUME DECREASE	Decrease volume	Volume Decreased
		Volume down	
		Decrease sound	
		Reduce volume	
13	SETTING HIGH SPEED ALERT ENABLE	Enable high speed alert	High speed alert setting enabled
14	SETTING HIGH SPEED ALERT DISABLE	Disable high speed alert	High speed alert setting disabled
15	END NAVIGATION	Cancel navigation	Navigation ended
		End navigation	
		Exit navigation	
		Stop navigation	

S. No.	Intent	Commands	Voice Feedback
16	BRIGHTNESS INCREASE	Brightness Increase	Brightness increased / Maximum brightness
		Brightness up	
		Brightness high	
		Increase brightness	
		Increase the speedo brightness	
		Increase the brightness	
		Turn up the brightness	
		Increase the brightness	
17	BRIGHTNESS DECREASE	Brightness decreased	Brightness decreased / Minimum brightness
		Brightness down	
		Brightness low	
		Decrease brightness	
		Decrease the speedo brightness	
		Turn down the brightness	
		Decrease the brightness	

## Note

*The list of commands and intent will be updated periodically. Please refer to the command list mentioned in the mobile application to stay updated.*

### **Things to do while using voice assistant:**

1. We recommend to use ANC (Active Noise Canceling) Bluetooth devices for better performance
2. Ensure Microphone is kept near to your mouth while giving out commands
3. Please ensure that it is not exposed to outside environmental noise such as wind noise, other vehicles' noise etc.
4. We recommend you to go through the sample command list before trying your intent.
5. Kindly refer to the voice feedback of the detected place name when you provide voice command for navigation.
6. Make sure you have the information tray of cluster displaying customer window when voice assist is invoked through vehicle switch.
7. Ensure your safety while using voice assist functionality

### **Things not to do while using voice assistant:**

1. We recommend you not to use the method of invoking voice assist through mobile App while riding.
2. Please do not use voice assist functionality during heavy traffic condition.

## Voice feedback

RONIN also has feature of voice feedbacks along with voice assist functionality.

Voice feedback feature communicates from vehicle to customer of either critical parameters like fuel level or rider warnings like direction indicators and side stand alert chimes. Some of the features in voice feedback like Turn on Mobile data, GPS signal low will work only in Voice assist mode as shown below:

SI. No.	Feature	Voice feedback	Display in cluster
1	If the signal strength is poor	Poor network	POOR NETWORK
2	If the GPS signal is poor	Low GPS signal	GPS SIGNAL LOW
3	Fuel low warning	Check fuel low	WARNING FUEL LOW
4	If mobile data is required for a particular feature but if mobile data is not ON	Turn on mobile data	TURN ON MOBILE DATA
5	If Location access is not provided	Need GPS permission	NEED GPS PERMISSION
6	If location access is required for a particular function but if GPS is OFF	Turn on GPS	TURN ON GPS
7	If ride is not started	Please start ride	PLEASE START RIDE
8	If phone battery is low	Phone battery low, Please connect to vehicle mobile charger	PHONE BATTERY LOW

Sl. No.	Feature	Voice feedback	Display in cluster
9	If side stand is in stand down condition	Alert chime	-No change-
10	If direction indicators is turned ON	Alert chime	-No change-
11	If the engine temperature is greater than threshold value	Take a Break, your bike is running hot	HIGH ENGINE TEMP
12	If the connected ride is for longer duration	Break Time	BREAK TIME
13	If the brightness of the cluster is maximum and increase brightness command is given	Maximum brightness	BRIGHTNESS XX%
14	If the brightness of the cluster is minimum and decrease brightness command is given	Minimum brightness	BRIGHTNESS XX%
15	If the volume of the mobile phone is maximum and increase volume command is given	Maximum volume	MAXIMUM VOLUME
16	If the volume of the mobile phone is minimum and decrease volume command is given	Minimum volume	MINIMUM VOLUME

## TVS CONNECT APP



Dedicated smart phone app is available in the Google Play and the Apple store for your 'TVS RONIN' and it can be installed in your Android smart phones and iPhones. To access the features of your TVS RONIN's connected instrument cluster like:

1. Incoming call alerts in connected instrument cluster.
2. Number of missed call alerts and unread messages in connected instrument cluster.
3. Battery status of your smart phone in connected instrument cluster.
4. To send auto reply SMS to the callers via smart phone (applicable only for Android smart phones).
5. 'Do Not Disturb' mode during the connected ride (applicable only for Android smart phones).
6. To send navigational assist instructions inputs to the connected instrument cluster from your smart phone.
7. To save the last traveled route.

8. To locate the last parked location of your TVS RONIN.
9. To know the signal strength of your mobile network in connected instrument cluster (based on smart phone OS version).
10. To generate and store Ride reports.
11. To sync the connected instrument cluster clock with smart phone clock.
12. To access voice assist and voice feedback functionality during connected rides.
13. To receive personalized messages and vehicle alerts during connected rides.

This dedicated mobile app of your 'TVS RONIN' can be downloaded from the Google Play and the Apple store by searching the key word 'TVS CONNECT' else by scanning the below QR code.



*Android*



*iOS*



## Note

*This smart phone app is compatible only for the smart phones with Android OS version 8.0 and above, iOS version 11 and above and the BLUETOOTH version 4.0 and above. **Android and Google Play are trademarks of Google LLC. App Store® and iOS are trademark of Apple. The smart phone app is updated time to time to capture upgrades to the mobile operating system. Though these updates are tested on the majority of the mobile phones in the market before release, it may lead to disablement of few functions on some of the operating system.***

## Warning

*TVS Motor Company Limited does not recommend usage of any type of Mobile Hand Held Devices, and applications / features whether installed or associated with the vehicle which deprives the rider's attention and focus while riding the Two Wheeler. The customers and riders are strictly advised to understand the applicable laws, road safety Rules and the local laws on usage of electronic devices while operating the vehicle. Usage of any Mobile or hand held devices, and / or applications / features while riding the vehicle is totally at customer's / rider's risk. The product and features have technical limitations and are for general overview only.*

## How to login

On opening the **TVS CONNECT** app the following introductory screens will be displayed.



Move to the last screen where you will find the 'SIGN UP' and 'LOGIN' tab. If you are already having login credentials, then press login tab. A screen with various login options opens-up as shown.

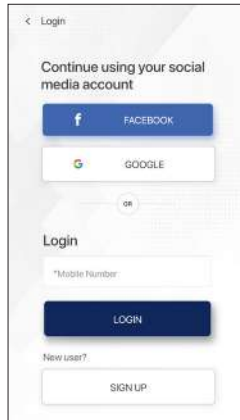

You can login using your social media logins like FACEBOOK and GOOGLE+ or using your mobile number which has been registered already.

If you are a new user then press the sign up tab where you will find various options for registering using your social media logins like FACEBOOK and GOOGLE+ or a tab for creating new account.

Using your social media logins you can create new login else press the 'CREATE AN ACCOUNT' tab.

On pressing the 'CREATE AN ACCOUNT' tab, a screen opens with various input details. Feed in your details and submit. On submitting the details a screen opens with one time password (OTP) entry.

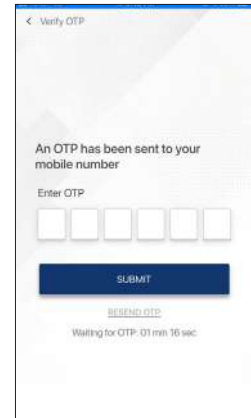
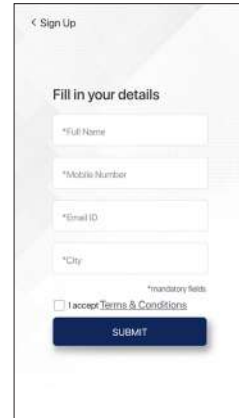

Enter the OTP which is received from TVS Motor Company Limited and submit. On submitting the OTP, another screen opens where you have to enter your vehicle's chassis number for verification.

## Add vehicle

Add vehicle tab allows you to add any of your TVS bikes by entering its chassis number. You can have sample view of the frame number and also you can get help by chatting with us or by E-mailing to us or by calling us.

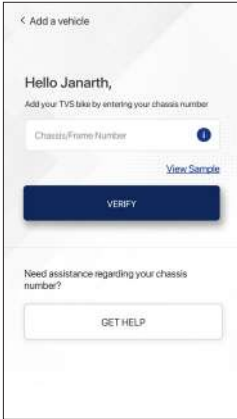

After successful verification of your chassis number, the Home screen of the app opens.

### Note

**Please remember that the Navigation License has to be renewed after 5 years of vehicle purchase and renewal can be done by contacting near by Dealer end.**

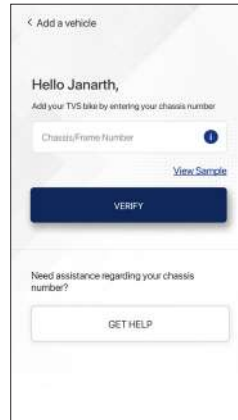

### **Illumination setting**

1. Press and hold the 'Mode' button for few seconds till the display enters 'CLOCK SETTING'.
2. Press 'Mode' button twice till the display 'illumination'.
3. Press 'Set' button to enter illumination setting.
4. Now Press 'Mode' button change the illumination from the range of 20% to 100%.
5. Press the 'Set' button again to set the illumination and to come out from illumination setting.

## COOLING SYSTEM

TVS RONIN is designed with an external oil cooler arrangement for optimal engine cooling.

The oil cooler is mounted in front of the engine which improves the engine durability and provides better heat management without compromising the engine performance.



## LED HEAD LAMP

TVS RONIN comes head lamp combined with front position lamp (FPL). FPL glows automatically once the ignition is turned ON and the head lamp glows on starting engine.



### Note

*To always have best lighting performance, always ensure to keep the head lamp and all other lamps outer lenses clean from dust or any other foreign particles.*

## HEAD LAMP AIMING

If you find any deviation in the head lamp beam focus of TVS RONIN, check the focus by following the procedure given below. If the focus is not within the specified limit mentioned in the illustration, get the head lamp focus adjusted at TVS Motor Company Authorised Main Dealer / Authorised Dealer.

To check the head lamp beam focus:

1. Place the vehicle as shown in the figure from the 5 meters screen / wall.
2. Mark the horizontal line on a screen around  $720 \pm 20\text{mm}$  from the ground level and mark the vertical line in middle of the horizontal line.

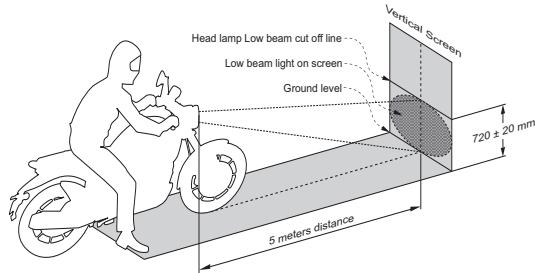

3. Sit on the vehicle to check the head lamp focus after the screen setup.
4. Start the vehicle and turn head lamp to high beam mode.
5. Rotate the handle bar to the left / right side and focus the head lamp on the vertical line of the screen.
6. Now, turn the head lamp to low beam mode.
7. Ensure the head lamp low beam focus into  $720 \pm 20\text{mm}$  from the ground level as shown.
8. If not, contact nearest TVS Motor Company Authorised Main Dealer or Authorised Dealer for head lamp focus adjustment.

### Note

*Head lamp beam adjustment requires removal of few fasteners which need to be done with additional care to avoid damages. Contact TVS Motor Company Limited Authorised Main Dealer or Authorised Dealer for getting it adjusted to the specified limit.*

*The specification for head lamp beam adjustment is applicable only for India. Owner's of other countries are advised to adopt the local rules and regulations.*

## FUEL TANK# CAP

Flush type fuel tank cap (1) is provided in TVS RONIN. To open the fuel tank cap, lift the protection lid (2), insert the control key into the lock. Turn the key in clockwise and lift the cap. Press the cap back to close. Rotate the key anti-clockwise and take out. Close the lid.

To avoid accumulation of water in the fuel tank, a small drain hole and a pipe is provided in the fuel tank lid cavity so that the water entering through the lid is drained out through a hose.



*# The fuel tank is not a measuring instrument and the capacity of the fuel tank may slightly vary from the indicated capacity.*

## Warning

*Do not smoke while refueling. Do not use cell phones while refueling. Avoid spilling of fuel on the hot engine. Refill fuel in well ventilated area.*

*Switch off the engine while refueling as petrol is highly inflammable. After refilling close the cap properly.*

## EVAPORATIVE EMISSION CONTROL SYSTEM

This vehicle is fitted with Evaporative Emission Control System (EVAP system with canister).

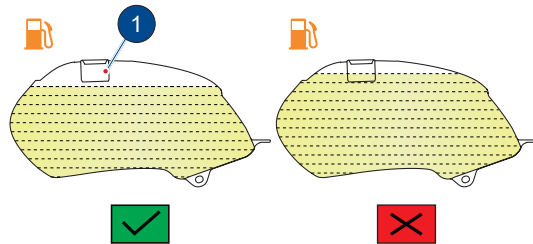

If there is any abnormal jerk, startability issue are felt in the vehicle or noise due to sudden escape of gas during opening of fuel tank cap, immediately report to the TVS Motor Company Authorised Main Dealer / Authorised Dealer.

### Caution

**Never fill fuel beyond the fuel tank inlet (1).** Filling above the inlet may result in improper breathing of fuel tank which leads to difficulty in starting as well as improper running of the vehicle.

Whenever refueling the bike fill only the recommended quantity of fuel (12 liters approx. including reserve).

Do not clean the vehicle by laying down on floor to avoid fuel entry into EVAP system.



## STANDS

TVS RONIN is equipped with a centre (1) and side stand (2).

To place the vehicle on the centre stand, hold the handle bar left grip with left hand and pillion handle with right hand. Place your foot firmly on the centre stand extension (1a) and press with adequate effort. Ensure both the legs of centre stand are touching the ground before placing the vehicle on the stand.

Side stand can be operated by sitting on the vehicle with your left foot by pushing it away from the vehicle to its extreme end.

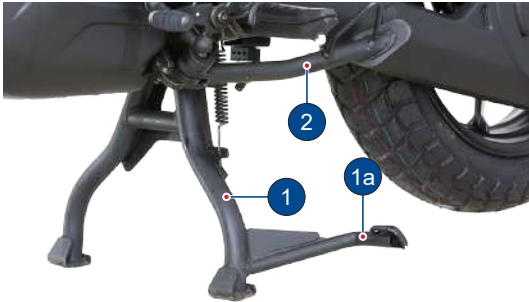

### Warning

*Park the motorcycle safely on a solid ground. On slopes, engage the first gear and park the vehicle in such a way that the front wheel faces uphill.*

***Always retract the side stand to its full up position before moving the vehicle. Else, the vehicle will get 'Switched OFF'.***

### Caution

*Do not sit on the vehicle when it is parked on the side stand / centre stand, as your full weight would rest on the vehicle's only support.*

## SEAT

The seat lock is located at the left side of the vehicle near the cover frame L.

### Removal

To remove the seat, insert the ignition key into the seat lock and turn it in clockwise direction. Pull and take out the seat by lifting it from the rear end and gently tapping it on the front end.



### Caution

*Make sure that the seat is locked securely in position.*

### Re-assembly

There are four hooks to lock the seat with frame. Ensure to locate these seat hooks into the frame guides and gently push the seat little foreword and press at rear end till you hear the 'click' sound.



### Caution

*Failing to lock the seat hooks in the frame guides lead to shaking of seat which may result in riding discomfort.*

## TOOL KIT AND FIRST AID KIT

To assist you in performing certain aspects of periodic maintenance and emergency repairs, a tool kit is supplied along with the vehicle.

A first aid kit is also available along with the tool kit. Both tool kit and first aid kit are located under the seat. To access the tool kit / first aid kit, remove the seat as explained in page no. 71. Tool kit consists of one number each of the following:

1. Grip driver
2. Bit (+) (-)
3. 12 x 14 open end spanner
4. Tool bag

### **Warning**

*Do not remove the tool kit and first aid kit from the vehicle. Always ensure to keep them along with the vehicle. Ensure the first aid equipments are changed periodically based on the date of expiry.*

### **Caution**

*It is recommended to use the tool kit in case of any emergency only. It is always advisable to take your vehicle to TVS Motor Company Authorised Main Dealer / Authorised Dealer.*



## COVER FRAME R



### Removal

Cover frame R is provided to access the battery and rear disc brake master cylinder. This cover can be opened in the following manner:

9. Remove the seat as explained in page No. 71.
10. Remove the mounting screws (1) & (2). Unplug the lugs at (3) & (4) and take out the cover frame.

### Re-assembly

1. Locate the lugs of the cover frame at the holes provided on the frame at (3) & (4) and install the mounting screws (1) & (2).

### Caution

*Make sure that the cover frame is locked securely in position after installation.*

## ADJUSTMENTS

### Clutch lever - Adjustment\*

TVS RONIN comes with an adjustable clutch lever. There are three positions provided for you to adjust the lever to suit your palm size. The lever can be adjusted by adjusting the position adjuster (A) provided in the lever itself. 'Position-1' is the closest to handle bar grip and 'Position-3' is the farthest.

To adjust the lever position, push the lever forward and rotate the position adjuster to any of the three positions by aligning the 'arrow mark' on the lever to the 'number' provided on the adjuster.

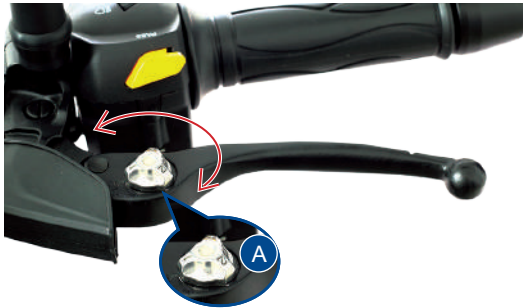

### Front brake lever - Adjustment\*

TVS RONIN comes with an adjustable front brake lever. There are three positions provided for you to adjust the lever to suit your palm size. The lever can be adjusted by adjusting the position adjuster (B) provided in the lever itself. 'Position-1' is the closest to throttle grip and 'Position-3' is the farthest.

To adjust the lever position, push the lever forward and rotate the position adjuster to any of the three positions by aligning the 'arrow mark' on the lever to the 'number' provided on the adjuster.

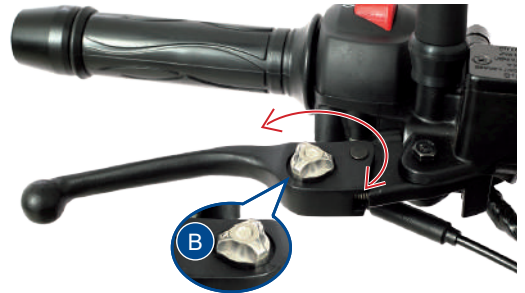

\* Applicable for Connected instrument cluster version only

 **Caution**

*Do not try doing any adjustment while riding as it may lead to fatal accident.*

*Do not use any tool or objects to turn the position adjuster. Do it by hand only.*

 **Note**

*While adjusting the lever position, ensure the proper aligning of position adjuster's number with the arrow mark on the lever.*

*Check and ensure the proper free play of both clutch and front brake after adjusting the lever position.*

**SMART PHONE CHARGER\***

A provision for fixing a smart phone charger has been provided on your vehicle. The smart phone charger supplied by the company can be fitted on your vehicle on chargeable basis. Ask your Dealer to fix the same if required. Please follow the guidelines mentioned below for using it properly:

**DO's**

1. Ensure that no water enters into the unit, by closing the USB flap properly.

2. Use the USB, if approved standard USB cable used for charging mobile.
3. Do make sure the flap is not damaged while opening / inserting the USB cable.

**DON'Ts**

1. Do not leave the USB charging flap open / partially closed.
2. Do not attempt to use / charge any other device, other than mobile phones. Only one mobile phone should be charged at a given time.
3. Do not try to force the USB connector in, check whether it is inserted in the appropriate direction, to prevent the damage to the charger.
4. Do not charge your mobile when engine is off.

 **Caution**

*The charging time of the mobile may vary, depending on the mobile's battery state of charge. The rubber flap in the unit has been designed to prevent water entry and is not replaceable.*

***No warranty for charger in case of rubber flap cut.***

*\* Optional accessories will be charged extra*

## PRE RIDE INSPECTION

Check the following items before riding

ITEM	WHAT TO CHECK FOR
Engine cum transmission oil	Availability of oil upto the level (page no. 80)
Fuel	Enough fuel for the planned distance of running
Tyres	Correct pressure (page no. 97) Adequate tread depth / No cracks or cuts.
Battery	Proper working of all lamps, horn and pass by switch. Low battery indication Battery charge (page no. 86)
Speedometer	Performing self check / Proper working of ABS warning lamp (page no. 11)
Malfunction indicator	Turned 'OFF' after starting the engine (page no. 29)
Steering	Smooth movement / No play or looseness
Throttle	Correct free play of cable / Smooth operation
Clutch	Correct free play of cable (page no. 92) / Smooth and progressive action
Brakes	Availability of brake fluid and proper working of brake (page no. 94)
Wheels	Free rotation
Drive chain	Slackness and lubrication of chain (page no. 100)

### **Caution**

*Do not switch 'ON' the ignition without minimum level fuel in tank. It will cause damage to the fuel pump.*

## STARTING THE ENGINE

As you turn the ignition switch to the 'ON' position, the instrument cluster and the warning lights will go through the self-diagnostic cycle. During this phase, make sure that all the warning lights on the cluster comes on.

The following conditions must be verified before starting the engine.

- ❑ The engine cut off switch is in 'O' position.
- ❑ Side stand is in retracted condition.
- ❑ The gear is in neutral.
- ❑ If gears are engaged, the clutch lever should be engaged fully.

Press the start button without applying the throttle. As soon as the engine starts, release the start button. The engine will not start/crank if the throttle is opened more than 30%.



### Caution

*Do not keep the engine in idling rpm for long.*

*Do not open excessive throttle when the vehicle is parked. It leads to overheating of engine and damage to the internal components.*

## SETTING THE VEHICLE IN MOTION

1. Press the clutch lever and engage first gear by pressing the gearshift lever down.
2. Open the throttle slowly and simultaneously, release the clutch lever gently and gradually. The vehicle starts moving forward.
3. As the vehicle picks up speed, shift to the next higher gear by closing the throttle, applying the clutch and lifting the gear shift lever up.
4. Release the clutch lever and open the throttle smoothly. Select the required gears in a similar manner.

### Using the transmission

The transmission is provided to keep the engine to run smoothly in its normal operating speed range.

The gear ratios have been carefully chosen to meet the characteristics of the engine. The rider should always select the most suitable gear to achieve the necessary speed and pulling power smoothly.



## Riding on hills/gradients

When climbing steep hills, the motorcycle may begin to slow down and show lack of power. At this point, the rider should shift to a lower gear so that the engine will again be operating in its normal power range. Shift gears rapidly to prevent the motorcycle from losing momentum.

When riding down a hill, the engine may be used as brake by shifting to a lower gear.

## STOPPING AND PARKING

1. Close the throttle completely and apply both the brakes simultaneously.
2. Down shift the gears with clutch lever pressed / disengaged as the road speed decreases. Bring the engine to neutral position just before the vehicle stops.
3. Turn the ignition 'OFF'.
4. Park the vehicle on a firm, flat surface.
5. Lock the steering.

## Warning

*Reduce speed to a safe limit before turning / cornering. Do not apply brake while turning / cornering. Do not disengage clutch before braking.*

*Since the engine and exhaust system becomes very hot, make sure to park the vehicle in a place where pedestrians or children are not likely to touch the hot surface. Do not park near dry grass or any other flammable resources which might catch fire.*

*To avoid deterioration of paint gloss due to ultra violet rays and heat of sunlight, always park your motorcycle in a covered parking.*

## FUEL RECOMMENDATION

Use only BS VI petrol with minimum RON 91.

BS VI petrol containing upto 10% of ethanol by volume can be used.

Higher ethanol content in petrol can

- degrade plastic and rubber components of fuel system and vehicle parts.
- cause corrosion damage to metal parts like fuel tank, etc.
- result in startability & drivability issues.
- decrease fuel economy.

Ethanol absorbs water very easily, resulting fuel separation. Extra care shall be taken to prevent moisture entry into fuel tank while filling ethanol blended petrol and water washing of vehicle. Painted parts (viz. panels, covers) shall not come in contact with ethanol blended fuels.

Manufacturer is not responsible for any warranty issues that results from using ethanol blend in excess of 10% by volume.

In case of any abnormalities observed due to use of ethanol blended fuels, customers are advised to use a different fuel station/brand for standard E10 fuel or contact authorised service centres.



### Caution

*Never mix oil and petrol in the fuel tank. Always fill fuel from reputed and reliable fuel stations.*

## CHECKS AND TIPS FOR IMPROVING FUEL ECONOMY

### Regular checks

Carry out the periodic maintenance checks as specified in this manual (refer page no. 83).

Regular maintenance checks will save fuel ensuring trouble-free, enjoyable and safe riding besides keeping the environment clean .

### Spark plug

A dirty or defective spark plug leads to wastage of fuel due to incomplete combustion. Inspect and clean the spark plug if necessary. Visually inspect the spark plug gap. If the gap is found more replace the plug with a new one.

**However the spark plug need to be replaced every 12000 kms or 1 year whichever is earlier. Always use recommended spark plug only.**



### Caution

*Do not remove the spark plug when the engine is hot.*

### Air cleaner element

A dirty air cleaner element restricts airflow and increases fuel consumption. **Replace the element every 12000 kms.**

Since paper filter is used in your motorcycle, it is not advised to clean the filter. Replace the filter in case of any abnormalities.

### Clutch

Increase in engine speed during acceleration and constant speed running, without increase in vehicle speed indicates clutch slip. The clutch slip will cause high fuel consumption, poor acceleration and overheating of engine.

If the condition persists even after adjusting the clutch lever play, immediately have the clutch checked by TVS Motor Company Authorised Main Dealer / Authorised Dealer.

### Caution

*Never drive the vehicle with the clutch lever pressed. This will reduce the life of clutch and affect the vehicle performance and fuel economy.*

### Engine cum transmission oil

Dirty or less engine cum transmission oil increases the friction between various parts of the engine and reduces the engine life, thereby increases fuel consumption.

**Regularly inspect the engine cum transmission oil for correct level and top-up if necessary. Get it replaced at regular intervals as per the maintenance schedule.** Always use TVS TRU4 FULLY SYNTHETIC oil only (SAE 10W 30 API-SL, JASO MA2).

### Fuel leak

If any fuel leak from tank is suspected, tow the vehicle to the nearest TVS Motor Company Authorised Main Dealer / Authorised Dealer.

### Tyres

Low tyre pressure has adverse effects on the vehicle. The **drag on the vehicle** increases resulting in decreased fuel economy. Further more, handling may be affected adversely.

### Caution

*Do not attempt to do any rectification, as fuel lines are normally pressurized upto 3.5 bar and any activity by any untrained personnel, may lead to un-safe condition.*

Check the tyre pressure regularly (weekly) and inflate it to the recommended pressure (refer page no. 97). Never use tyres which are worn out beyond the permissible limit.

### **Chain slackness**

Check and ensure drive chain slackness. Excess slackness leads to higher fuel consumption (refer page no. 100).

### **Wheels free movement**

Check and ensure the free movement of wheels by rotating them at least once in a week to avoid wastage of fuel.

### **Fast starting from rest wastes fuel**

A racing start from rest at full throttle will waste fuel and damage the engine. It also creates a potentially dangerous traffic situation. Fuel is wasted whenever the rider suddenly accelerates or applies the brake.

### **Avoid unnecessary idling**

While waiting for someone or stopping in signals for long time, if the engine is kept running at idle speed, it causes unnecessary wastage of fuel.

### **Avoid frequent braking**

Anticipate corners and slopes as well as the traffic conditions. **Unnecessary and frequent braking reduces the fuel economy.**

### **Note**

*The on-road mileage of TVS RONIN is dependent on several factors like road condition, quality of fuel, riding speed, operation of clutch and brake, tyre inflation, maintenance / timely servicing of vehicle, load etc. and hence will differ from the mileage given under standard test conditions such as made in recognised institutes.*

## MAINTENANCE SCHEDULE

The maintenance schedule indicates the intervals between periodic services. At the end of each interval, be sure to inspect, check, replace, adjust, lubricate and service as instructed. If the maintenance is not done periodically, it will result in rapid wear and severe damage to the vehicle. If the vehicle is used under high stress conditions such as continuous full throttle operation or is operated in dusty area, certain jobs should be performed more often to ensure reliability of the vehicle. Cylinder head, steering components, suspension, chain and wheel components etc., are key items and require very special and careful servicing. TVS Motor Company Limited strongly recommends that the jobs as per the maintenance schedule be performed by your TVS Motor Company Authorised Main Dealer / Authorised Dealer.

Periodic inspections may reveal one or more parts that may need replacement. Whenever replacing parts on TVS RONIN, it is recommended that you use only the TVS Motor Company Genuine parts.



### Caution

*Proper running-in and maintenance are mandatory for making certain that your vehicle is reliable and gives optimum performance at all times. Make sure that the periodic maintenance is performed thoroughly in accordance with the instructions given in this owner's manual.*

*In more dusty areas, the air filter element required early replacement than the mentioned kilometers to avoid costly damages to the engine.*



## PERIODIC MAINTENANCE SCHEDULE (months or km whichever occurs earlier)

PERIOD FROM THE DATE OF SALE	SERVICE km	In free service			After free service	Remarks
		1st 750 - 1000 30 - 45 days	2nd 5500 - 6000 6 months	3rd 11500 - 12000 12 months	Every 6000 km 6 months	
ITEMS	ACTIVITY					
Engine cum transmission oil	Replace	R	R	R	R	
Oil filter (Stainer)	Clean	C	C	C	C	
Oil filter element	Replace	R	R	R	R	
Spark plug	Replace	–	–	R	–	Replace every 12000 km
Air cleaner element	Replace	–	–	R	–	Replace every 12000 km
Tappet clearance	Inspect	I	I	I	I	
Clutch and throttle play	Inspect and adjust	I & A	I & A	I & A	I & A	
Steering smooth operation / play	Inspect, adjust and lubricate	I	I	I	I	Adjust if required. Lubricate every 24000 km
Front fork oil	Replace	–	–	–	–	Replace every 36000 km if required (in case of inefficiency in functioning or cases of oil leak)
Front and rear suspension	Inspect for proper functioning	I	I	I	I	
All fasteners	Inspect and tighten	I & TI	I & TI	I & TI	I & TI	
Drive chain**	Clean, lubricate and adjust	C, L & A	C, L & A	C, L & A	C, L & A	
Chain guide bottom	Inspect	–	–	I	–	Inspect and replace if required

\*\* Clean the drive chain with TRU SPRAY chain cleaner and dry cloth. Apply TRU SPRAY / TRU 4 oil as frequently as every 500 km for better chain life and smooth vehicle running. Check drive chain, rear sprocket and engine sprocket for wear. If any part is worn, replace the same. Always replace the engine sprocket, rear sprocket and chain together.

SERVICE km PERIOD FROM THE DATE OF SALE	ACTIVITY	In free service			After free service	Remarks
		1st 750 - 1000 30 - 45 days	2nd 5500 - 6000 6 months	3rd 11500 - 12000 12 months	Every 6000 km 6 months	
<b>ITEMS</b>	<b>ACTIVITY</b>					
All bulbs, horn and switches	Inspect for proper functioning	I	I	I	I	
Battery voltage and terminals	Inspect	I	I	I	I	
Brake effectiveness / Brake system leak if any	Inspect	I	I	I	I	
Brake pedal shaft	Lubricate	L	L	L	L	
Brake pad wear / Brake fluid / WSS cable clamps / Brake hose / Bundy tubes / HECU mounting cushions	Inspect	I	I	I	I	
Malfunction indicator lamp	Check with Diagnostic tool	-	-	-	-	Connect ride scan tool if MIL glows, check and clear DTCs
Wheel freeness	Inspect	I	I	I	I	
Tyre pressure	Inspect	I	I	I	I	
Centre / side stand pivot	Lubricate	L	L	L	L	
Swing arm bearings	Clean and Inspect	-	-	-	-	Clean and lubricate every 24000 km
Wheel balancing	Inspect and adjust	-	-	I & A	-	Inspect and adjust every 12000 km
Master cylinder cups		-	-	-	-	Replace every 24000 km

R - Replace; I - Inspect; C - Clean; A - Adjust; L - Lubricate; TI - Tighten

## RECOMMENDED LUBRICANTS

APPLICATION	QTY	MANUFACTURER	BRAND
Engine cum transmission oil	1300 ml (after draining) 1500 ml (after disassembly)	TVS Motor Company	TVS TRU4 FULLY SYNTHETIC oil SAE 10W30 API-SL, JASO MA2)
Front fork oil	RH front fork - 500 ± 2 cc LH front fork - 525 ± cc	-	SHOWA SS-47G
Disc brake fluid	-	TVS Girling	DOT 3 / DOT 4
Grease	-	Bharat petroleum IOC Bechem	MP Grease no. 3 Servo Gem no. 3 Bechem premium grade 3
Chain cleaner	-	TVS Motor Company	TRU SPRAY chain cleaner
Chain lubricant	-	TVS Motor Company	TRU SPRAY



## SELF - MAINTENANCE PROCEDURES

### BATTERY

To ensure better performance and long life of battery, you are requested to follow the steps given below:

1. Remove the cover frame R (refer page no. 73).
2. Check the battery voltage. If the voltage measured is less than 12.4 Volts, charge the battery using TVS Motor Company Limited recommended battery charger only at TVS Motor Company Authorised Main Dealer / Authorised Dealer.
3. Adding any additional electrical accessories other than TVS Motor Company recommended ones, may lead to disqualification of warranty coverage.



4. While connecting the terminals, observe the correct polarity. Connect the red wire to the '+' terminal and black wire to the '-' terminal of the battery.
5. Apply petroleum jelly to the terminals to avoid corrosion.

Incase of any abnormality or for removal of the battery from the vehicle, contact TVS Motor Company Authorised Main Dealer / Authorised Dealer.

### **Caution**

*Never check the battery charge by shorting the terminals. Always connect the positive terminal first (red wire) and then negative (black wire) to avoid sparking.*

*The inversion of the battery wires can damage the battery and the recharging system.*

*If the motorcycle is to remain unused for a long time (a month or longer), it is advisable to disconnect the battery cables or have the battery removed by skilled personnel.*

## Recommendations to maintain battery health during prolonged parking conditions

While your vehicle is parked for prolonged duration, battery continues to discharge and if left unattended can get completely discharged. It is recommended to ride the vehicle for minimum 60 km every week to keep the battery in healthy condition. This could be at a stretch in one ride or several rides during the week. The vehicle speed will vary during the ride but an average speed of minimum 30 km/h will be helpful to ensure proper battery charging. To conserve battery charge during such period. This is only a recommendation to maintain battery charge and regular service schedules must be followed to maintain your vehicle in good running condition.

The following are the recommendations to the users regarding battery maintenance before, during and after long storage of battery:

### 1. Before Storage

- a. Store the battery only after fully charging it.
- b. Battery fuse to be disconnected and stored safely. This will reduce the sleep mode current and hence enhance storage life of battery.\*
- c. Alternatively, battery connecting wires

(positive and negative wires) can be disconnected and fasteners can be secured with battery terminals.\*

### 2. During Storage

- a. Store it at room temperature or lower.
- b. Store the vehicle in the shade and protected from rain and cover the vehicle to prevent rodents from entering and damaging the wires.

### 3. After Storage

- a. Connect the wires and fuse, if disconnected earlier, with ignition switch in OFF position\*
- b. Start the vehicle by kick starting.

(Above recommendations do not consider storage effects on other systems such as induction and fuel systems and wheels)

### Periodic Maintenance of Batteries:

- Keep top of battery clean.
- Check cables, clamps, and case for obvious damage or loose connections.
- Clean terminals and connectors as necessary.

\* To be done by skilled personnel

- Recharge battery if voltage is below 12.4 Volts.
- Valve Regulate Lead Acid (VRLA) / Lead Acid batteries are prone to water damage. Any water entry, through vents or otherwise; will result in irreparable damage to the battery or the vehicle.

### **Warning**

*Battery develop explosive gases. Keep it away from heat sources. If charging is required the battery must be charged in well ventilated area.*

*Unusable battery must be disposed in environment friendly manner. Do not discard it with household trash. Handover the battery to the battery Dealers or to a recycle center that accept used battery.*

### **Caution**

*Never operate the vehicle with discharged battery as it may damage electrical components.*

*Do not push start the vehicle, use a good battery to start the vehicle.*

## **FUSE REPLACEMENT**

The electrical components of your motorcycle are protected by five fuses. Out of which four fuses are housed inside a fuse box and located inside the cover frame near the battery. One more main fuse is located below the fuel tank.

### **To access the fuses located below cover frame R:**

1. Turn 'OFF' the ignition.
2. Park the motorcycle on a flat firm surface and remove the cover frame R as explained in page no. 73.
3. Open the fuse box lid.
4. The fuse box contains 10A fuse, 15A fuse, 20A fuse and 25A fuse each one.

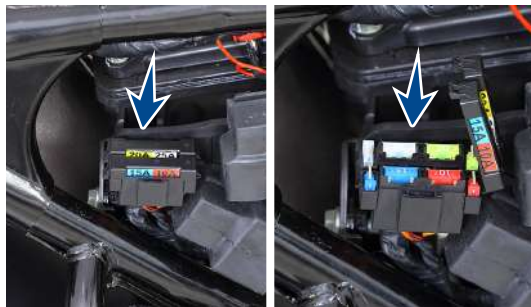

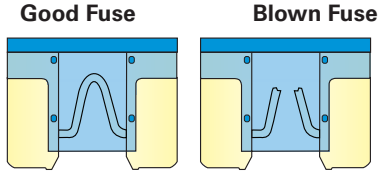

5. Open the fuse and pull out the required fuse.
6. Replace the blown fuse with a new one with same rating (extra fuses are provided inside the fuse case itself).
7. Close the fuse case and re-fix case.
8. Turn 'ON' the ignition lock and check for proper functioning of electrical and ABS system. In case if the fuse fails again, consult the nearest TVS Motor Company Authorised Main Dealer / Authorised Dealer.

 **Caution**

Do not use vehicle by **shorting the wires without a fuse**. This may result in overheating of electrical / wiring and may result in fire. Never replace a fuse with a rating other than that prescribed, in order to avoid damage to the electrical equipment.

**To access the fuse located below fuel tank:**

1. Fuel tank needs to be removed to access the 60A Main fuse.
2. Replace the blown fuse with a new one with the same rating (extra fuse (A) is provided in the fuse holder itself).
3. Turn 'ON' the ignition lock and check for proper functioning of electrical. In case if the fuse fails again and to remove fuel tank, consult the nearest TVS Motor Company Authorised Main Dealer / Authorised Dealer.

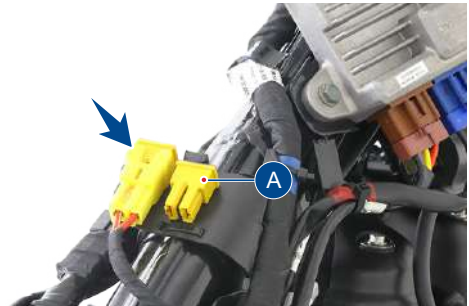

## SPARK PLUG

1. Wipe and clean the dust and mud around the spark plug mounting to avoid their entry inside the cylinder.
2. Pullout the suppressor cap from spark plug.
3. Remove the spark plug using a plug spanner.

A spark plug with heavy carbon deposits will not produce strong sparks. Hence, only if necessary, remove the carbon deposits from the spark plug with a small wire brush or spark plug cleaning tool.

Inspect the spark plug electrodes (A) and (B) for any corrosion. If found any replace the spark plug with a new one.

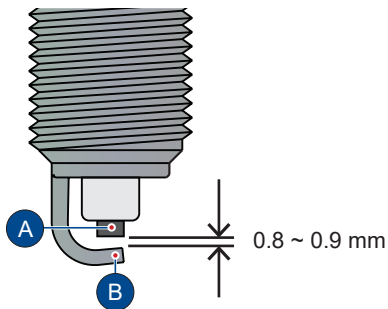

Visually inspect the spark plug gap. The gap should be 0.8 to 0.9 mm. If the gap is found to be more, replace the spark plug with a new one.

After cleaning and inspecting the gap, reinstall the spark plug and tighten by hand to avoid cross threading. Finally tighten using the spanner. Do not over tight or cross thread the spark plug. After reassembling the plug fix back the suppressor cap and ensure its proper fitment.

### Caution

*Always use only recommended make and type of spark plug. Since the hook type spark plug is used, it is not advised to adjust the plug electrodes as it may damage the electrodes. **Replace spark plug every 12000 km or 1 year whichever is earlier.***

*Cover the spark plug hole with a cloth when the plug is removed to prevent entry of dust / water.*

*Do not remove the spark plug when the engine is hot. It is advisable to tight the new spark plug by hand till the end and then loose. Again re-tight the spark plug by 1/8 of rotation after sealing by using only the hand tool.*

## ENGINE CUM TRANSMISSION OIL

Check the engine cum transmission oil level periodically. The gauge oil level is provided at the right-hand side crankcase cover. The check must be performed when the engine is in cold condition, after placing the motorcycle in center stand with front wheel touching the ground.



1. Place the motorcycle in an upright position on a horizontal and firm surface.
2. Wipe-off the surroundings of gauge oil level.
3. Remove the gauge oil level and wipe it clean.
4. Re-insert the gauge oil level by completely screwing it in.
5. Once again remove the gauge and check the oil level.

6. The oil level should be between the minimum and maximum level marks on the gauge as shown in the figure.
7. If the oil level is below the minimum level, top up with TVS TRU4 FULLY SYNTHETIC oil (SAE 10W30 API-SL, JASO MA2) upto the maximum level mark. Do not overfill.
8. Wipe out the oil traces with a clean cloth to prevent dust accumulation and re-fix the gauge.

### **Caution**

*Do not run the vehicle with insufficient / without engine cum transmission oil as it will cause serious damage to the engine components.*

*Excessive oil filling will cause oil leak and other malfunctions. Always use TVS TRU4 FULLY SYNTHETIC oil only (SAE 10W30 API-SL, JASO MA2).*

*Make sure that no foreign object gets in the crankcase while topping up the engine oil.*

### **Warning**

*Correctly recycle or dispose the used engine oil in order to avoid environmental pollution.*

## CLUTCH ADJUSTMENT

Clutch lever free play is one of the most important adjustment which you may need to check in-between services for better life of the clutch plates. The free play of the clutch lever should be 8 to 13 mm as measured at the clutch lever end at handle bar before the clutch begins to disengage.

Adjust the clutch lever free play periodically by means of clutch cable adjuster at arm clutch release if the free play is found more.

1. Ensure that the engine is cold (engine oil at room temperature).



2. Loosen the lock nut (2) while holding the clutch cable adjusting nut (1). Adjust the clutch cable adjusting nut (1) 'in' or 'out' to give sufficient play in the clutch lever.
3. After adjusting the play hold the adjuster nut in the same position and tighten the lock nut.



### **Caution**

Too much or too less clutch lever free play will damage the clutch plates, thereby affecting the performance of the vehicle. **Adjust the clutch lever free play only when the engine is cold.** After adjusting free play properly, if there is a clutch slip or there is difficulty in shifting gear, visit your TVS Motor Company Authorised Main Dealer / Authorised Dealer for rectification.

## REAR SHOCK ABSORBER

TVS RONIN is provided with dual rated, 7 step adjustable, gas filled rear shock absorber to meet different road and load.



### **Warning**

The rear shock absorber contains highly compressed gas. Do not try to open or disassemble it in any way.

### **Caution**

Adjust step by step. Do not go at a stretch as it will damage the cam.

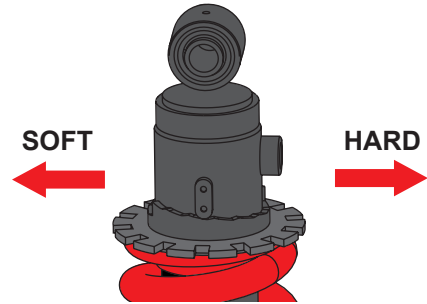

### **Note**

During the time of delivery of the motorcycle, the rear suspension is adjusted to the standard configuration.

Rear shock absorber spring stiffness can be set to your convenience. Contact your TVS Motor Company Authorised Main Dealer / Authorised Dealer for setting the rear shock absorber load.



## BRAKES

### Front brake

You can observe a master cylinder (1) on the right side of the handle bar, a caliper assembly (2) fitted to the fork leg R along with a wheel speed sensor (3), a disc (4) and the toner ring (5) to the front wheel. Also you can observe a high pressure hose connecting the master cylinder to the HECU of ABS system and another hose connecting HECU to the caliper assembly.

1. Check the master cylinder brake fluid level through the view piece glass (A).

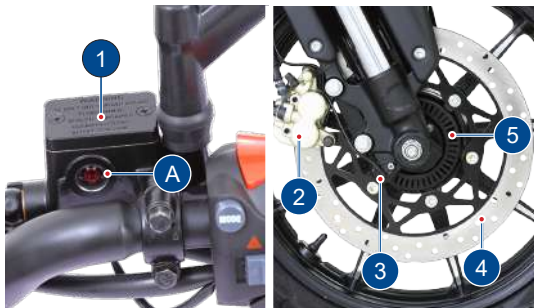

2. Brake fluid level always should be above the 'LOWER' mark (B) on the master cylinder when the master cylinder is parallel to the ground.
3. If the brake fluid level is below the mark or while applying brake if you feel the brake is more spongy or ineffective due to air entry, contact TVS Motor Company Authorised Main Dealer / Authorised Dealer for topping-up the brake fluid, air bleeding and other brake related inspections.



### Note

*Check the brake fluid level only when the master cylinder is parallel to the ground.*

## Rear brake

You can observe a master cylinder (1) mounted on the right side rider foot rest, a reservoir (2) below the cover frame R, a caliper assembly (3) fitted on the rear wheel axle along with wheel speed sensor (4)\*, a disc (5) and toner ring (6)\* to the rear wheel. Two high pressure hoses connecting the master cylinder to HECU\* and HECU\* to the caliper (in single channel ABS version high pressure hose is connected directly to the caliper assembly).

1. Remove the cover frame R (refer page no. 73 for removal procedure).

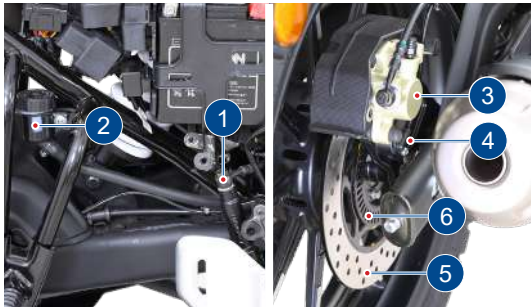

\* Not applicable single channel ABS version

2. Check the brake fluid level in the reservoir. It should be between maximum and minimum level.
3. If the brake fluid level is below minimum or while applying brake if you feel the brake is more spongy or ineffective due to air entry, contact TVS Motor Company Authorised Main Dealer / Authorised Dealer for topping-up the brake fluid, air bleeding and other brake related inspections.



### Note

Check the brake fluid level only when the master cylinder is parallel to the ground.

### Brake pad wear indicator

Visually check the brake pads for wear. If the wear is found beyond the wear indicator groove as shown in the figure then, replace the brake pads as a set with a new one.

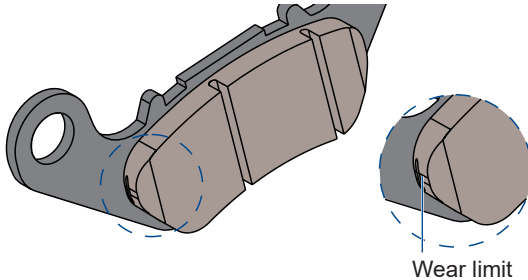

### **Warning**

*Lack of maintenance of the brake system increases the risk of accident. If you notice any malfunction in brake system contact nearest TVS Motor Company Authorised Main Dealer / Authorised Dealer.*

### **Caution**

*Replace the brake pads as a set, if the wear indicator shows beyond the wear limit.*

## TYRES\*

### Tyre pressure:

Check the tyre pressure atleast once in a week if not more frequently. Insufficient air pressure in the tyres not only hasten tyre wear, but also seriously affects the stability of the vehicle.

Under-inflated tyres make smooth cornering difficult and over-inflated tyres decreases the tyre contact with the ground which can lead to skidding and loss of control. Be sure that the tyre pressure is within the specified limits at all times.

	Solo	Pillion
Front	1.75 kg/cm <sup>2</sup> (25 psi)	1.75 kg/cm <sup>2</sup> (25 psi)
Rear	1.97 kg/cm <sup>2</sup> (28 psi)	2.25 kg/cm <sup>2</sup> (32 psi)

### Warning

*The tyre inflation pressure in cold condition and the tyre thread condition are extremely important for the performance and safety of the rider. Check the tyres frequently for inflation pressure as well as the wear pattern on it. **Use of a tyre other than the standard will cause instability.***

### Tyre tread condition

Operating the vehicle with excessively worn tyres will decrease riding stability and can lead to loss of control. It is recommended to replace the tyre when the tyre wears off to the tyre wear indicator level (indicated by TWI on the tyre).

### Tyre rotation direction

While reassembling the tyre, after removing from wheel rim, ensure that the arrow mark (A) provided on the tyre facing the direction of wheel rotation.



\* **The pneumatic tyres fitted in this vehicle meet the requirements specified by BIS and comply with the requirements under the Central Motor Vehicles Rules (CMVR), 1989.**

## Tyre puncture

TVS RONIN is fitted with a tubeless tyre on both front and rear wheel. In case of any puncture / tyre damage it is advised to visit nearest tyre manufacturer Dealer or the tyre repair shops who know the repairing methods of tubeless tyre.

It is not necessary to remove the tyre from wheel rim always to attend the puncture. Even though, if there is a need of tyre removal, it is strongly recommended to use a tyre removal / fitment machine.

If at all, tyre levers need to be used, the levers should be free from sharp edges and care should be taken not to damage the rim and tyre.

## Warning

*Use of a tyre other than the standard may cause instability and improper function of ABS.*

*Keep the toner ring upwards whenever the wheel is removed in order to avoid damage to the toner ring. Damaged toner ring affects the ABS function.*



## Caution

*Side walls of the tubeless tyres which are in contact with the wheel rim are only seals the air inside the wheel assembly. Hence, care should be taken not to damage the side walls of the tyres during removal / reassembly.*

***Wheel balancing to be done every 1 year or every 12000 km and also after every tyre puncture repair or tyre replacement to have better high speed performance.***

## Tyre Maintenance Tips

### Inflation Pressure Check - Condition



### Note

*If vehicle is in hold condition for long time*

- *Need movement of vehicle to avoid particular spot of tyre not to touch the ground for more than week time.*
- *Inflation pressure should check on cold condition maximum travel time should not exceed more than 1 km.*
- *Weekly basis inflation pressure check helps to improve 10% of tread life & fuel efficiency.*

## DRIVE CHAIN

Proper lubrication and adjustment of drive chain gives long service life of the chain. Poor maintenance of the chain causes premature wear or damage to the drive chain and sprockets. **Poor chain maintenance also affects mileage of the vehicle.**



### Warning

*Riding with improperly adjusted chain / high slackness can cause the chain to come off the sprockets resulting in accident or serious damage to the motorcycle. Misalignment of rear wheel or sprockets can cause abnormal wear of chain and sprockets and results in unsafe riding condition.*

The drive chain must be cleaned, checked, lubricated and adjusted at specified intervals mentioned in the maintenance schedule.

**Even though the chain is cleaned, lubricated and adjusted during regular service by the Dealers, the user must clean the chain with TRU SPARY chain cleaner & dry cloth and lubricate with TRU SPRAY / TRU4 oil as frequently as every 500 km for better chain life and smooth vehicle running.**

Check, clean, lubricate and adjust the drive chain in the following manner:

1. Place the vehicle on centre stand with the transmission in neutral.
2. Clean the chain in the as explained below:
  - Turn OFF the engine.
  - Shake the TVS TRU SPRAY chain cleaner bottle well.
  - Rotate the rear tyre so as the chain, front and rear sprockets rotate along with it. Apply TVS TRU SPRAY chain cleaner front and sideways.
  - Clean the chain using soft brush.
  - Repeat the steps if needed until the dust is removed completely.
  - Let the vehicle be parked for 10 ~15 mins to ensure the chain is dry.

3. After the chain is completely dry, apply TVSTRU4 Chain Lub by rotating the rear wheel by hand in forward direction.
4. Now, check the slackness of the drive chain (as shown). The slackness of the drive chain should not exceed the limit (maximum 20 ~ 25 mm). Excess slackness consumes more fuel.
5. If the slackness is found more contact TVS Motor Company Authorised Main Dealer / Authorised Dealer for adjustment.

 **Caution**

*Lubricate the drive chain after the motorcycle is washed with water or riding in rainy / wet condition.*

*The chain must be serviced more frequently when the vehicle is operated under severe conditions like dusty, muddy, wet, high speed or frequent starting / stopping.*



## FRONT WHEEL REMOVAL AND REASSEMBLY

1. Slightly loosen the axle nut (1)
2. Loosen the left side clamping screws (2) and (3).
3. Now, remove the axle nut along with a washer.
4. Support the front wheel and slowly pull out the quick-release axle (4) from the left side.
5. Place a support below the frame to prevent vehicle from falling and lift the vehicle up.
6. Carefully dislocate the disc from the caliper assembly and slide the wheel out.
7. Reverse the procedure for reassembling.

### Warning

*Ensure proper seating of disc in the caliper assembly while reassembling the wheel.*

*Ensure to re-fix the right spacers at both the sides of the wheel.*

*Keep the toner ring upwards whenever the wheel is removed in order to avoid damages to the toner ring. Damaged toner ring affects ABS function.*

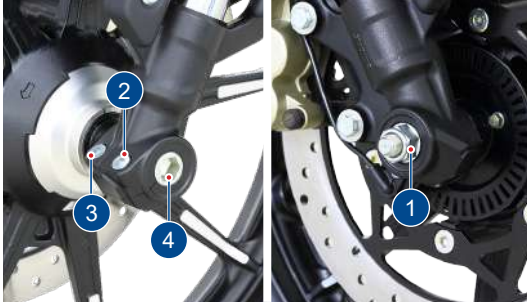

## REAR WHEEL REMOVAL AND REASSEMBLY

1. Remove the wheel hugger rear.
2. Remove the axle nut (1) along with the washer and partially pull out the axle (2).
3. Take out the caliper assembly along with the wheel speed sensor\* by dislocating it from the disc and the swing arm lug.
4. Carefully hang the caliper assembly in the swing arm itself. Take out the spacer and pull out the axle fully.
5. Remove the wheel assembly by gently tapping it along with the disc and toner ring\*.

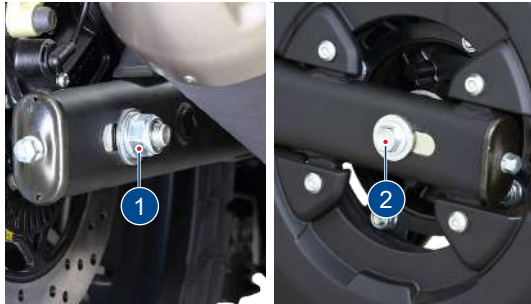

\* Not applicable single channel ABS version

6. During re-assembly, engage the drum sprocket with the wheel along with the drive chain and then assemble the wheel into swing arm.
7. Re-assemble the other parts in the reverse order of removal.

### Warning

*Keep the toner ring upwards whenever the wheel is removed in order to avoid damages to the toner ring. Damaged toner ring affects ABS function\*.*

### Caution

*While assembling the caliper assembly ensure that the slot provided in the caliper is properly located to the lug provided in the swing arm assembly.*

*Always make sure that whenever the wheel is removed, axle nut is properly re-tightened to the specified torque and chain play is re-checked and adjusted if required.*

### Note

*During removal of rear wheel axle hold the drum sprocket assembly with the hand as it may fall. Carefully hang the drum sprocket along with chain in the swing arm itself.*

## STORAGE PROCEDURES

For storage of your motorcycle for longer periods of over a month and above, we recommend to carry out the following steps:

1. Clean the vehicle thoroughly. Park the vehicle on centre stand.
2. Warm up the engine and drain engine cum transmission oil. Store the oil, if new, in a dust free container.
3. Empty the fuel tank.
4. Remove the spark plug and feed in several drop of engine cum transmission oil through spark plug hole. Crank the engine few times and reinstall the spark plug.
5. Remove the battery, store it away from direct sunlight and freezing temperatures.
6. Place a suitable support at the bottom of the frame so that both the tyres are off the ground. This will ensure better tyre life.

### **Warning**

*The exhaust system becomes hot after a run. Park the vehicle in a place where pedestrians or children are not likely to touch the vehicle.*

7. Cover up the vehicle completely with a clean tarpaulin or any other suitable cover. Store the vehicle inside a garage or similar area to avoid damage due to dust and rain. Make sure that the storage area is well ventilated and free from any source of flame or spark.

### **Caution**

*Do not park the vehicle on a slope or soft ground or else it may fall.*

*During storage, the battery must be recharged on a TVS Motor Company recommended battery charger atleast once in a month.*

## TAKING THE VEHICLE OUT OF STORAGE FOR REGULAR USE

1. Take the vehicle out of the garage and clean it thoroughly.
2. Remount the battery after bench charging if required.
3. Fill the engine cum transmission oil (TVS TRU4 FULLY SYNTHETIC - SAE 10W30 API-SL, JASO MA2) and check the oil level using the gauge.
4. Lubricate the parts as instructed in the maintenance schedule.
5. Fill up fresh petrol in the fuel tank.
6. Check and inflate the tyres to the specified tyre pressure.
7. Check and correct the points mentioned in page no. 76.
8. Turn the ignition switch to 'ON' position. Retract
9. the side stand if the vehicle is parked on side stand. Start the engine and allow it to idle for a few minutes and ride out.



### Caution

*Avoid using alkaline solution like detergent soaps for washing. This may damage head lamp and other lamp assemblies.*

## RECOMMENDED TIPS WHEN TAKING A LONG TRIP OF MORE THAN 500 KM

- A) Please keep the following items for use in case of emergency:
  1. Complete tool kit / first aid kit
  2. Recommended spark plug one number.
  3. Throttle and clutch cables one number each.
- B) Precautions to be taken for the journey:
  1. Ensure engine cum transmission oil and brake oil level are up to the level.
  2. Adequate fuel in fuel tank.
- C) Check your motorcycle for the following:
  1. Tightness of all bolts and nuts with correct torque value.
  2. Fitness of tyres / tyre pressure / tread depth.
  3. All bulbs, indicators and horn function.
  4. Balancing of wheel.
  5. Check for the proper functioning of ABS (through ABS warning lamp)
  6. Smooth functioning of all cables and their free plays.
  7. Smoothness of steering operation.

8. Slackness and lubrication of chain (page no. 100)
9. Front / rear brake functioning and rear brake lamp switch adjustment.
10. Front fork for any abnormality.
11. Spark plug cleanliness and condition of spark plug.
12. Air filter element cleanliness.
13. Lubrication of all items mentioned in the periodic maintenance schedule.
14. Intactness of EVAP system hoses and canister.
15. Any other job as necessary.
16. Have your vehicle checked at any TVS Motor Company Authorised Main Dealer / Authorised Dealer.

**Caution**

*Long journey are to be taken only after the running-in period of 1000 km.*

**Note**

*Ensure the first aid equipments are changed periodically based on the expiry.*

**TVS Motor Company Limited ('the Company') give this warranty with respect to the TVS RONIN manufactured by the Company.**

While the Company has taken every care to maintain quality in the manufacture of the TVS RONIN, the above said warranty is subject to other terms of warranty:

During 5 Years from the date of purchase or during the first 60,000 km of run for the vehicle in the hands of original retail purchaser, whichever is earlier, the parts of the vehicle covered under warranty which prove to the satisfaction of the Company to have a manufacturing defect will be repaired or replaced free of cost.

The Company's obligation under this warranty is limited to repairing or replacing, free of cost, those parts of the vehicle which upon examination by the Company may prove to the Company's satisfaction to have a manufacturing defect, and in such cases the Company's decision either to repair or replace the affected parts will be final. In the event of replacement of parts, the Company also reserves the right to use parts of the same brand as the affected parts or any other brand which is used by the Company in the course of manufacture. All parts replaced under this warranty will become the property of the Company and must be returned to the company.

**Limitations of Warranty:**

This warranty shall not apply to following condition:

1. Any natural wear and tear, including without limitation, aging.
2. Warranty claims on proprietary items such as tyres, tubes and batteries etc., should be preferred by the user directly on the respective manufacturer, as per their warranty terms and the Company shall not be liable in any manner in respect to the same.
  - Battery warranty for "MF type (Maintenance Free)" is applicable for a period of 21 months from the date of charging or 18 months from the date of sale or 20,000 kms, whichever is earlier.
  - Battery warranty for "Lead Acid type" is applicable for a period of 15 months from date of charging or 12 months from date of sale or 10000 kms whichever is earlier.
3. Parts repaired or replaced under this warranty are warranted only throughout the remainder of the original warranty period.

4. The Company is not liable for any delay in servicing due to reasons beyond the control of the Company or any of its Authorised Main Dealers / Authorised Dealers.
5. In any event, the Company is not liable for indirect, remote, incidental or consequential damages.
6. The Company may make any modification or improvement to vehicles in future production at any time without prior notice and without any obligation to install the same on vehicles previously dispatched for sale.
7. Any claim under this warranty will lie only when the customer:
  - takes his vehicle to an Authorised Main Dealer / Authorised Dealer of the Company and reports the problem he / she felt in the vehicle to enable the Authorised Main Dealer / Authorised Dealer to inspect the same and assess the cause for the reported problems.
  - produces to such Authorised Main Dealer / Authorised Dealer the Service Handbook for the concerned vehicle for verification of relevant details.
8. This is the only warranty given by the Company for the TVS RONIN. No employee, Dealer or other person is authorised to extend or enlarge this warranty.

 **Warning**

*Modifications to this vehicle not approved by the TVS Motor Company may cause loss of performance and render it unsafe for use and disqualifies for warranty coverage also.*

**Following Toll Free numbers can be contacted for battery related queries if any.**

*Incase of EXIDE battery, call :- 1800 103 5454*

*Incase of AMCO battery, call :- 1800 425 0096*

*Incase of TATA GREEN battery, call :- 1800 419 8888*

*Incase of AMARON battery, call :- 1800 425 5858*

**Following Toll Free numbers can be contacted for Tyre related queries if any.**

*Incase of TVS Srichakra, call :- 04522443300*

*Incase of JK tyre, call :- 18002581100*

*Incase of Maxxis tyre, call :- 1800 532 2888*

### List of parts not covered under warranty

ITEM	WHAT TO CHECK FOR
Normal Maintenance Operations	Engine tune-up, decarbonizing, fuel system cleaning, oil changes, head light focusing, fastener retightening, ignition timing, clutch and brakes as well as other normal adjustments.
Wear & Tear items	Chain, sprockets, clutch and brake linings, fasteners, shims, washers, oil seals, gaskets, O' rings and spokes etc.
Electrical	Led lamps, fuse, AHO etc
Service Maintenance Parts	Oil filters, spark plug, air filter, Engine cum transmission oil and brake fluid
Rubber, Rexine & Plastic items	All hoses , pipes and plastic aesthetics
Proprietary Items	<p>Battery, tyres and tubes (the warranty terms are subject to our agreement with proprietary OEM)</p> <p>(Battery warranty for "MF type (Maintenance Free)" is applicable for a period of 21 months from the date of charging or 18 months from the date of sale or 20,000 kms, whichever is earlier).</p> <p>(Battery warranty for "Lead Acid type" is applicable for a period of 15 months from date of charging or 12 months from date of sale or 10000 kms whichever is earlier).</p>
Others Factors	Parts of the vehicle getting affected due to atmospheric effect / environmental factors (rusting, paint peel off etc.). However, depending on the vehicle usage condition, warranty would be accepted up to 2 years from the date of purchase.



ITEM	WHAT TO CHECK FOR
Others Factors	Parts of the vehicle which have been tampered with, altered, repaired or replaced by persons not authorised by the Company and which in the sole judgement of the Company affect the performance of the vehicle.
	Parts which are used in conjunction with parts not made or recommended by the Company.
	Parts suffering damage or resultant damage by accident, misuse, negligent treatment, use of bad quality lubricants or impure fuel or by omission to follow the guidance and instructions contained in this owner's manual.
	Vehicles on which any warranty service including scheduled paid service is not availed when it falls due (at TVS Motor Company Authorised Main Dealer / Authorised Dealer).
	<p>Vehicles sold or transferred by original retail purchaser.</p> <p>Vehicles used for racing or any competition or used otherwise than for ordinary personal transportation.</p> <p>Vehicles attached with side cars etc.</p> <p>Vehicles which have been taken out of India.</p> <p>Vehicles affected by natural calamities like flood, earthquake, tsunami, storm etc.,</p>
	If the vehicle has been used for commercial purpose like taxi or used for rental or hiring or any other purpose other than regular personal transportation.

## SERVICE INFORMATION

There are eleven services for TVS RONIN during warranty period. Of these, first three services are free services for which labour charges are free. In addition to these three free services, we have a scheme of eight pay services. For keeping the maintenance track of your vehicle, a free and pay service record sheets are attached with this Service Handbook. Please have the record sheets filled by the Dealer who is carrying out the maintenance service.

Before you avail your first free service, please enter the particulars of your vehicle on the left side of this page. This will be useful for any reference.

For availing any of the eleven warranty services, please take your vehicle and your Service Handbook to any of our Authorised Main Dealer or any of our Authorised Dealer. After effecting the service, the Authorised Main Dealer or the Authorised Dealer will affix their stamp on the last column of the free or pay service record sheet for your record and reference. An OTP would be sent to customer's registered mobile number. The same to be shared with the servicing Dealer on or before vehicle delivery.

Periodic maintenance always helps good performance of an automobile and our services are planned to keep your TVS RONIN performing good. **Please note that carrying out the service for your vehicle at scheduled intervals at any of the TVS Motor Company Authorised Main Dealer / Authorised Dealer is necessary for availing warranty.** And please also remember that, after the services are over, periodic servicing of your vehicle at appropriate intervals, depending upon its extent of use, will keep your vehicle at its best level of performance.

In case you need any clarification or assistance, please feel free to write to us mentioning the frame number, engine number and date of purchase of your vehicle also the name and place of the Authorised Main Dealer / Authorised Dealer from whom you bought the vehicle and getting it serviced.

### Service Department

**TVS MOTOR COMPANY LIMITED**

**PO.Box No. 4, Harita, Hosur - 635 109,**

**TAMILNADU, INDIA.**

**Toll free no. :- 1800-258-7111**

## PLANNED SERVICE SCHEDULE (kms or month whichever of the two occurs early)

SL.NO.	SERVICE	TYPE	KMS	MONTHS
1	1st Service	Free	750 ~ 1000	30 ~ 45 days
2	2nd Service	Free	5500 ~ 6000	6
3	3rd Service	Free	11500 ~ 12000	12
4	4th Service	Pay	17500 ~ 18000	18
5	5th Service	Pay	23500 ~ 24000	24
6	6th Service	Pay	29500 ~ 30000	30
7	7th Service	Pay	35500 ~ 36000	36
8	8th Service	Pay	41500 ~ 42000	42
9	9th Service	Pay	47500 ~ 48000	48
10	10th Service	Pay	53500 ~ 54000	54
11	11th Service	Pay	59500 ~ 60000	60

### Note

Free service enables the customer to avail the service at free of labour charges. Charges for the pay service should be borne by the customer. Cost of engine oil, periodic maintenance parts, filter, brake fluids, all types of greases, petroleum jelly, distilled water, chain cleaner, lubricants, coolants, cleaning cloths for both free and paid services are chargeable to the customer.

\* Please remember that, after the above schedule, periodic servicing of your vehicle at appropriate intervals, depending upon its extent of use, will keep your vehicle at its best level of performance.



**Drive In.**

**Drive Out.**



**Say bye-bye to waiting time  
for servicing your bike.**

**Get your vehicle serviced in 1 hour at no additional cost. Contact your nearest Dealership for details.†**

† Facility available at selected Dealerships only. Terms and conditions apply



# Busy Life? Easy Servicing!

Now, service your bike anywhere, anytime.

- ★ Service the vehicle at your door step.
- ★ Available for regular maintenance or breakdown service only.
- ★ Offered at nominal convenience charges.

**Contact your nearest Dealership for details.<sup>†</sup>**

<sup>†</sup> Facility available at selected Dealerships only. Terms and conditions apply





# Busy Life? Easy Servicing!

Now, service your bike anywhere, anytime.

- ★ Service the vehicle at your door step.
- ★ Available for regular maintenance or breakdown service only.
- ★ Offered at nominal convenience charges.

**Contact your nearest Dealership for details.<sup>†</sup>**

© Facility available at selected Dealerships only. Terms and conditions apply

DESCRIPTION	TVS RONIN	
	Single channel ABS	Dual channel ABS
<b>MANUFACTURER</b>	TVS MOTOR COMPANY LIMITED P.B. No1, Bythahalli, Kadakola post, Mysore - 571 311, India.	
<b>ENGINE</b>		
Type	Single cylinder, 4 stroke, fuel injection, oil cooled OHC	
Cylinder bore	66 mm	
Stroke	66 mm	
Piston displacement	225.9 cm <sup>3</sup>	
Compression ratio	10.14 ± 0.5 : 1	
Air filter	Viscous Paper filter	
Oil filter	Wire mesh and micronic paper filter	
Lubrication system	Forced wet sump	
Maximum power in kW	15.01 kW @ 7750 rpm	
Maximum torque in Nm	19.93 @ 3750 rpm	
Maximum speed	120 km/h in 5th gear	
Engine idling rpm (under warm condition)	1300 ± 200 rpm	
Starting system	Electric starter (ISG)	
Emission norms	BS VI	

DESCRIPTION	TVS RONIN	
	Single channel ABS	Dual channel ABS
<b>TRANSMISSION</b>		
Clutch	Wet - multiplate type	
Gear shift pattern	1 down and 4 up	
Primary transmission	Helical gears	
Secondary transmission	Chain and sprockets	
<b>GEAR RATIO</b>		
I gear	2.917	
II gear	1.857	
III gear	1.333	
IV gear	1.050	
V gear	0.880	
Primary reduction	2.818	
Secondary reduction	3.230	



DESCRIPTION	TVS RONIN	
	Single channel ABS	Dual channel ABS
<b>CHASSIS</b>		
Overall length	2040 mm	
Overall width	805 mm	
Overall height	1170 mm	
Sear length	795 mm	
Ground clearance (unladen)	181 mm	
Kerb weight (with toolkit and 90% of fuel)	159 kg	160 kg
Pay load	135 kg	
Maximum laden weight	294 kg	295 kg
Steering angle	35° (both sides)	
Caster angle	27°	
Frame	Double Cradle Split Synchro STIFF (DCSSS)	
Front suspension	USD front forks	
Rear suspension	Gas charged Mono Shock with 7 step adjustable with elliptical swingarm	
Trail length	110.4 mm	

DESCRIPTION	TVS RONIN	
	Single channel ABS	Dual channel ABS
<b>BRAKES</b>		
Front	Hand operated, 300 mm petal disc	
Rear	Foot operated, 240 mm petal disc	
<b>TYRE</b>		
Front tyre size	110 / 70 - 17 (Tubeless)	
Rear tyre size	130 / 70 - 17 (Tubeless)	
Front tyre pressure*	1.75 kg/cm <sup>2</sup> (25 psi)	
Rear tyre pressure - Solo*	1.97 kg/cm <sup>2</sup> (28 psi)	
Rear tyre pressure - Dual*	2.25 kg/cm <sup>2</sup> (32 psi)	

\* *The pneumatic tyres fitted in this vehicle meet the requirements specified by BIS and comply with the requirements under the Central Motor Vehicles Rules (CMVR), 1989.*

DESCRIPTION		TVS RONIN	
		Single channel ABS	Dual channel ABS
<b>ELECTRICAL</b>			
Ignition system		ECU - 3D Ignition timing map	
Spark plug		BOSCH - UR4KE	
Spark plug gap		0.8 to 0.9 mm	
Battery type		VRLA (MF) 12V, 6Ah	
Generator (flywheel magneto)		12V, 335W	
Head lamp		12V, LED Head lamp with AHO (30W/ 12W)	
Position lamp		12V, LED (2.5W x 1)	
Tail / brake lamp		12V, LED (0.8W / 5W)	
Turn signal lamps		12V, LED (4W x 4)	
Number plate lamp		12V, LED (1.5W x 1)	
Instrument panel		LCD / LED indicators	
Horn		12V, DC x 1	
Fuse	Main	12V, 60A x1	
		12V, 25A x 1	
		12V, 20A x 1 (dual channel ABS) / 12V, 15A x 1 (single channel ABS)	
	DC Load	12V, 15A x 1	
	EMS	12V, 10A x 1	

DESCRIPTION	TVS RONIN	
	Single channel ABS	Dual channel ABS
<b>CAPACITIES</b>		
Fuel tank capacity <sup>#</sup>	14 l	
Fuel	BS VI petrol with minimum RON 91 (containing upto 10% of ethanol by volume)	
Engine cum transmission oil grade	TVS TRU4 FULLY SYNTHETIC OIL (SAE 10W30 API-SL, JASO MA2)	
Engine cum transmission oil qty	1300 ml (after draining) 1500 ml (after disassembly)	
Front fork oil grade	SHOWA SS-47G	
Front fork oil capacity	Leg L - 525 ± 2 cc Leg R - 500 ± 2 cc	
Brake fluid grade	TVS Girling DOT 3 / DOT 4	

 **Caution**

**Additional electrical equipments is not acceptable as it will void the warranty terms of the vehicle.**

 **Note**

*Specifications and competence are subject to change without notice.*

<sup>#</sup> The fuel tank is not a measuring instrument and the capacity of fuel tank may slightly vary from the indicated capacity.

Dear Customer,

It is mandatory under the Motor Vehicles Act to insure all motor vehicles. No motor vehicle can be used in a public place without a valid policy of insurance issued by an authorised insurer. Driving a motor vehicle without any such insurance is an offense under Motor Vehicles Act.

To assist our Customers on their insurance requirements such as the prompt issue and renewal of policies as well as expeditious settlement of claims if any, our preferred insurers are:







TVS Motor Company Limited, P.B. No. 4, Harita, Hosur - 635 109, Tamil Nadu, India.  
Tel: +91 (4344) 276878 / 277311. <http://tvsmotor.com/tvs-ronin>